

K-MC1

radar transceiver

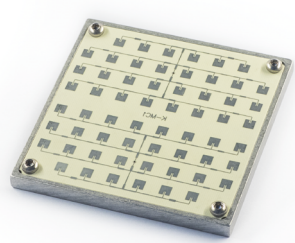

Features

- 24 GHz short range transceiver
- 300 MHz sweep FM input
- High sensitivity, with integrated RF/IF amplifier
- Dual 30 patch antenna
- Buffered I/Q IF outputs
- Additional DC IF outputs
- Beam aperture 25°/12°
- RSW Rapid Sleep Wakeup
- Slim 6mm thickness construction
- Available as 3.3V or 5V version

Applications

- Traffic supervision
- Object speed measurement systems
- Ranging and distance detection using FSK or FMCW
- Industrial sensors

Description

K-MC1 is a 60 patch doppler module with an asymmetrical narrow beam for long distance sensors. It is ideally suited for traffic supervision.

This module includes a RF low noise amplifier and two 47dB IF preamplifiers for both I and Q channels. The need for external analogue electronics will be significantly reduced by this feature. For special signal condition applications, an additional buffered Mixer DC output is provided. This greatly improves flexibility in FSK ranging applications.

The unique „RSW“ Rapid Sleep Wakeup function with <4us wakeup time makes this module ideal for battery operated equipment. Typical duty cycle in RWS mode may be < 1% with full movement detection capability by sampling the IF signals.

An extremely slim construction with only 6mm depth gives you maximum flexibility in your equipment design.

Powerful starter kits with signal conditioning and visualization are available. (ST100/ST200)

Block Diagram

Figure 1: Blockdiagram

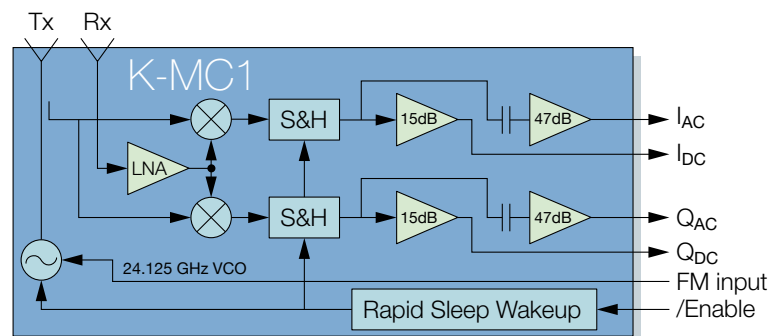

CHARACTERISTICS

Parameter Conditions/Notes Symbol Min Typ Max Unit

Operating conditions K-MC1-RFB-xxC (3.3V Version)

Supply voltage ^{Note 1}		V_{CC}	3.13	3.3	3.47	V
Supply current	Module enabled (Pin 1 = V_{IL})	I_{CC}		90	100	mA
	Module RSW mode (Pin 1 = V_{IH})			7	10	mA
VCO input voltage		U_{VCO}	0		3.3	V
VCO pin resistance	Internal voltage divider ^{Note 2}	R_{VCO}		20k		Ω
Operating temperature		T_{op}	-20		+85	$^{\circ}C$
Storage temperature		T_{st}	-20		+85	$^{\circ}C$

Operating conditions K-MC1-RFB-xxD (5V Version)

Supply voltage ^{Note 1}		V_{CC}	4.8	5.0	5.2	V
Supply current	Module enabled (Pin 1 = V_{IL})	I_{CC}		90	100	mA
	Module RSW mode (Pin 1 = V_{IH})			7	10	mA
VCO input voltage		U_{VCO}	0		10	V
VCO pin resistance	Internal pullup to 5V	R_{VCO}		4.7k		Ω
Operating temperature		T_{op}	-20		+85	$^{\circ}C$
Storage temperature		T_{st}	-20		+85	$^{\circ}C$

Power down/Enable

Module power down	Input tied high with pullup 10k	V_{IH}	$V_{CC} - 0.7$		$V_{CC} + 0.3$	V
Module enable		V_{IL}	-0.2		2	V
Minimum enable time	Sample&Hold capacitor charged	t_{on}	4			μs
Maximum hold time	S&H error <10%	t_{off}			2	ms
Hold Step	Charge injection visible at DC output	V_{step}		6		mV

Transmitter

Transmitter frequency	VCO Pin open, $T_{amb} = -20^{\circ}C \dots +85^{\circ}C$	f_{TX}	24.050	24.125	24.250	GHz
Frequency drift vs temp.	$V_{CC} = 5.0V, -20^{\circ}C \dots +85^{\circ}C$ ^{Note 3}	Δf_{TX}		-0.13		MHz/K
Frequency tuning range		Δf_{VCO}		300		MHz
VCO Modulation Bandwidth	$\Delta f = 20$ MHz	B_{VCO}		3		MHz
Output power	EIRP	P_{TX}		+16.5		dBm
Spurious emission	According to ETSI 300 440	P_{spur}			-30	dBm

Receiver

Antenna gain	$F_{TX} = 24.125$ GHz ^{Note 2}	G_{Ant}		18.5		dBi
Receiver gain	$F_{RX} = 24.125$ GHz	G_{LNA}		19		dB
Receiver sensitivity	$f_{IF} = 500$ Hz, $B = 1$ kHz, S/N = 6 dB	P_{RX}		-123		dBm
Overall sensitivity	$f_{IF} = 500$ Hz, $B = 1$ kHz, S/N = 6 dB	D_{system}		-141		dBc

IF output

IF output impedance	_AC outputs	R_{IF_AC}		100		Ω
	DC outputs	R{IF_DC}		100		Ω
IF Amplifier gain	_AC outputs	G_{IF_AC}		32		dB
	DC outputs	G{IF_DC}		0		dB
I/Q amplitude balance	$f_{IF} = 500$ Hz, $U_{IF} = 100$ mVpp (_AC outputs)	ΔU_{IF}	-2	0	+2	dB
I/Q phase shift	$f_{IF} = 500$ Hz, $U_{IF} = 100$ mVpp (_AC outputs)	φ	80	90	100	$^{\circ}$
IF frequency range	-3 dB Bandwidth (_AC outputs)	f_{IF_AC}	40		15k	Hz
	-3 dB Bandwidth (_DC outputs)	f_{IF_DC}	0		500	kHz
IF noise voltage	$f_{IF} = 500$ Hz	$U_{IFnoise}$		22		$\mu V/\sqrt{Hz}$
	$f_{IF} = 500$ Hz	$U_{IFnoise}$		-93		dBV/Hz
IF output offset voltage	AC outputs	U_{os_AC}	$V_{CC}/2 - 0.5$	$V_{CC}/2$	$V_{CC}/2 + 0.5$	V
	no object in range, VCO pin open, DC outputs	U_{os_DC}	0.5	$V_{CC}/2$	$V_{CC} - 0.5$	V
Supply rejection	Rejection supply pins to _AC outputs, 500Hz	D_{supply}		-50		dB

Parameter	Conditions/Notes	Symbol	Min	Typ	Max	Unit
-----------	------------------	--------	-----	-----	-----	------

Antenna

Horizontal -3dB beamwidth	E-Plane	W_{ϕ}		12		°
Vertical -3dB beamwidth	H-Plane	W_{θ}		25		°
Horiz. sidelobe suppression		D_{ϕ}		-20		dB
Vert. sidelobe suppression		D_{θ}		-18		dB

Body

Outline Dimensions	connector left unconnected			65 × 65 × 6		mm3
Weight				50		g
Connector	Module side: AMP X-338069-8			8		pins

ESD Ratings

Electrostatic Discharge	Human Body Model Class 1A	VESD			500	V
-------------------------	---------------------------	------	--	--	-----	---

Note 1 Use a low noise voltage source.

Note 2 The VCO Input has an internal voltage divider. If the VCO Pin is left open the voltage is typically 1.65V.

Note 3 Transmit frequency stays within 24.050 to 24.250 GHz over the specified temperature.

Note 4 Theoretical value, given by design.

TABLE OF CONTENTS

Product Information	1
Features	1
Applications	1
Description	1
Antenna System Diagram	5
Pin Configuration	5
Outline Dimensions	6
Application Notes	6
Using VCO and Internal IF Amplifier	6
Sensitivity and Maximum Range	8
Integrators Information	9
Installation Instruction	9
United States (FCC) and Canada (ISED)	10
Europe (CE-RED)	11
Order Information	12
Datasheet Revision History	12

ANTENNA SYSTEM DIAGRAM

This diagram shows module sensitivity (output voltage) in both azimuth and elevation directions. It incorporates the transmitter and receiver antenna characteristics.

Figure 2: Antenna system diagram (logarithmic scale)

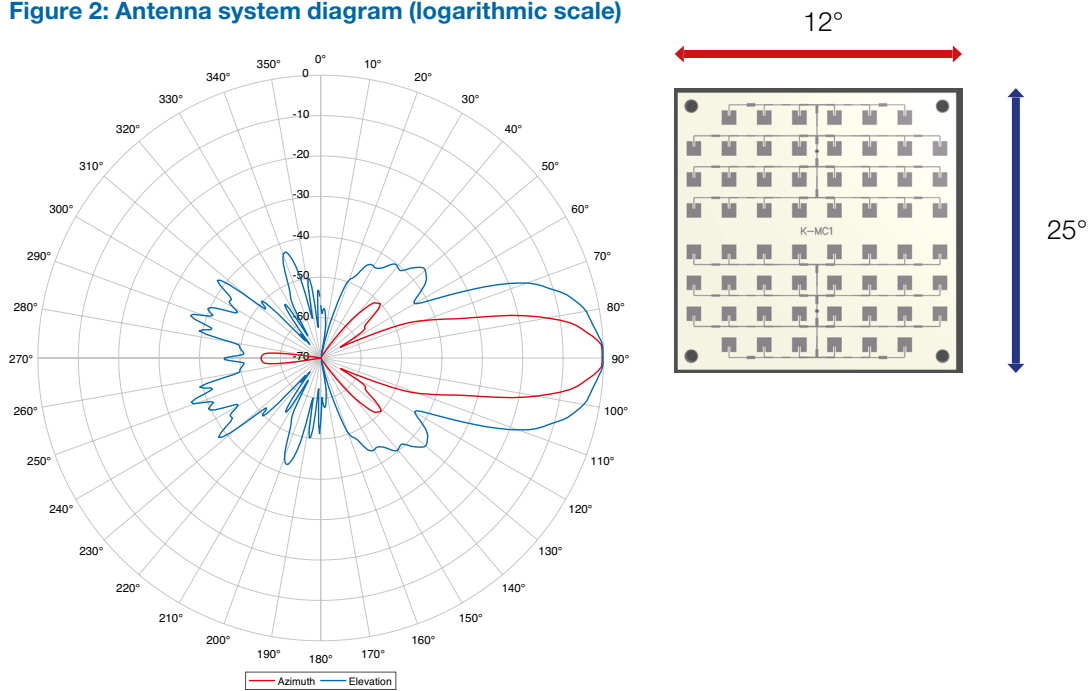

PIN CONFIGURATION

Table 1: Pin function description

Pin No.	Name	Description
1	/Enable	GND: module active
2	VCC	DC Supply V+
3	GND	Supply GND
4	IF output Q_AC	High gain intermediate frequency output Q, typical load: 1 k Ω
5	IF output I_AC	High gain intermediate frequency output I, typical load: 1 k Ω
6	VCO in	U_{VCO} or left open
7	IF output I_DC	Low gain intermediate frequency output I, typical load: 1 k Ω
8	IF output Q_DC	Low gain intermediate frequency output Q, typical load: 1 k Ω



Do not touch open connector pins. RFbeam K-MC1 radar module is susceptible to electrical discharge as long as it is not placed in the circuit.

OUTLINE DIMENSIONS

Figure 3: Mechanical dimensions

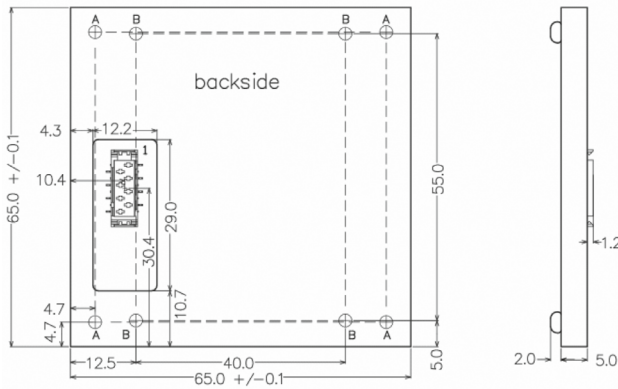

Mounting instruction

Mount from back side using thread marked with B: M2.5 screws, screw depth < 3.5mm

Alternate mounting:

Original screws A may be unscrewed and replaced by M2 screws for fixation on a holder. **K-MC1 modules must not be used without screws in A.** The antenna PCB is glued into the case against damage, but not for practical use of the module.

APPLICATION NOTES

Using VCO and Internal IF Amplifier

The IF amplifier provides two outputs per channel according to Fig. 1. These outputs are designed for different requirements in processing radar signals. Both I (In Phase) and Q (Quadrature) mixer signals are available. The I and Q signals are phase shifted by +90° or -90°, depending on the moving direction of objects in range.

FMCW generates an output signal even without an object in range because of the finite isolation between transmitter and receiver path. This effect is called self-mixing and leads to a DC signal that depends on the carrier frequency. Using FMCW, these signals move and may overdrive the 2nd stage (x_AC outputs) of the IF amp under certain circumstances.

Example showing a single target:

Triangle VCO Amplitude: 8 Vpp
 Triangle period $T_M = 14$ ms.
 Modulation depth $f_M = 160$ MHz
 IF output freq. $f_b = 450$ Hz
 Speed of light $c_0 = 3 \cdot 10^8$ m/s

Figure 4: x_AC Output FMCW signals with triangle VCO and $df = 160$ MHz

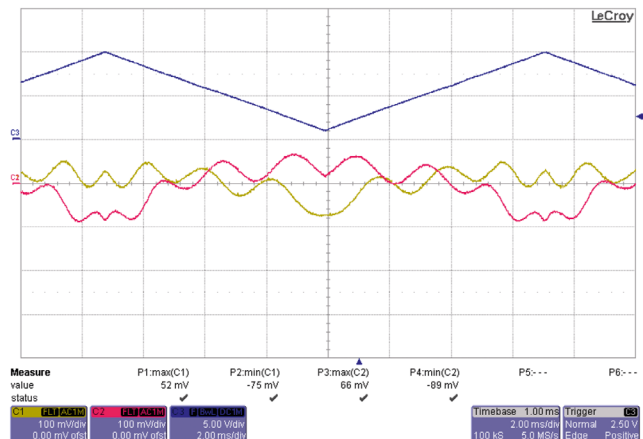

I_AC and Q_AC outputs show a low frequency caused by local carrier feedthrough.

The superposed higher frequency f_b is often called beat frequency, caused by a target at a distance of about 3 m.

The distance R to the target can now be calculated:

$$R = \frac{c_0}{2} \cdot \frac{f_b}{f_M} \cdot \frac{T_M}{2} = 3 \text{ m approximately}$$

Please contact RFbeam Microwave GmbH for more informations on FMCW and also on FSK applications.

I_AC and Q_AC High Gain Outputs

These outputs provide high gain/low noise signals generated by doppler effects or FMCW. They directly can drive ADC input stages of microprocessors or DSPs. Even with 10 Bit of resolution only, sensitive and relatively long range Doppler detections are possible. The outputs cover a frequency range of 40 Hz ... 15 kHz.

However, these outputs may saturate and clip because of too high input signals. In these cases you may use the x_DC outputs described below.

I_DC and Q_DC Low Gain Outputs

The low gain DC outputs (I_DC and Q_DC) hardly enter into a saturation state and may be used in cases, where the high gain outputs (I_AC and Q_AC) are clipped because of high input signals. Saturation and clipping typically arise in conjunction with FMCW and may be caused by objects nearby the sensor, noncompensated radoms etc.

These outputs carry more signal information than the x_AC outputs because of their bandwidth ranging from DC to 500 kHz. Using ADCs with resolutions of 12 Bits and more and processing with DSP processors allow versatile and flexible radar applications.

RSW in Action

This graph shows the sampling signal at pin/Enable and a resulting output signal at an x_AC pin caused by an approaching object.

This signal may be processed ,as is' or used as trigger to start continuous acquisition.

If RSW mode is used only to detect any movement, aliasing effects are not important (i.e. undersampling is useful).

By choosing a sampling frequency, aliasing must be taken into account, if frequency measurements are intended.

Rapid Sleep Wakeup (RSW)

RFbeam's unique rapid sleep wakeup feature allows power savings of more than 90 % during ,silent' periods. The module may be used in a relaxed sampling mode as long as no movements are detected. RSW also helps saving power, if not the full IF bandwidth of 15 kHz is needed.

In battery operated equipment such as traffic control, RSW may significantly lower battery and equipment volume and cost.

Figure 5: Sampled Doppler signal at x_AC outputs

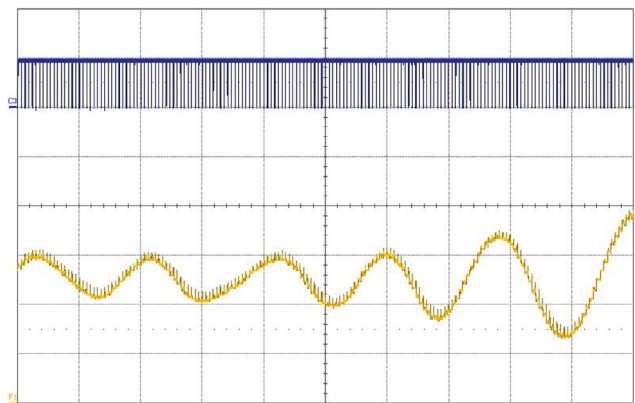

RSW principle

RSW combines switching of the RF oscillator and sample&hold of the mixer signals (please refer to Fig. 1: K-MC1 Blockdiagram). During sleep mode (pin /ENABLE = high), only the amplifiers stay switched on to hold the output voltage and coupling capacitor charges. This assures minimum peaks at the outputs when returning to the active state.

Nevertheless, we have to take some important effects into account. An important effect is charge injection, caused by the digital control signal.

Sampling sequence

To simplify signal processing sequence, output sampling may be done immediately after /ENABLE goes high (1) or before next /ENABLE (2). (See Figure 6)

Both methods have their advantages and disadvantages:

- Sampling point (1) contains a constant overshoot, i.e. sampled output signal becomes shifted by a constant DC component. There is no loss of sensitivity.
- Sampling point (2) corresponds to the real mixer output, as long as sleep time is short enough. But with longer off times, signal amplitude decreases.

Sensitivity and Maximum Range

The values indicated here are intended to give you a ‘feeling’ of the attainable detection range with this module. It is not possible to define an exact RCS (radar cross section) value of real objects because reflectivity depends on many parameters. The RCS variations however influence the maximum range only by $\sqrt[4]{\sigma}$.

Maximum range for Doppler movement depends mainly on:

- **Module sensitivity**
S: -141 dBc (@ 1kHz IF Bandwidth)
- **Carrier frequency**
 f_{TX} : 24.125 GHz
- **Radar cross section RCS “reflectivity” of the object**
 σ^1): 1 m² approx. for a moving person
> 50 m² for a moving car

note ¹⁾ RCS indications are very inaccurate and may vary by factors of 10 and more.

Figure 6: x_AC output is influenced by charge injection caused by switching signal

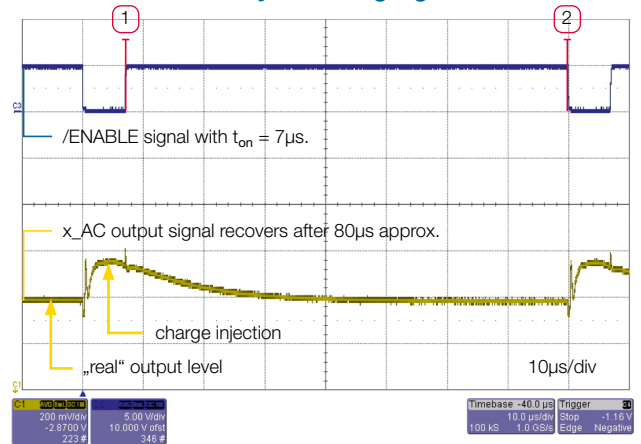
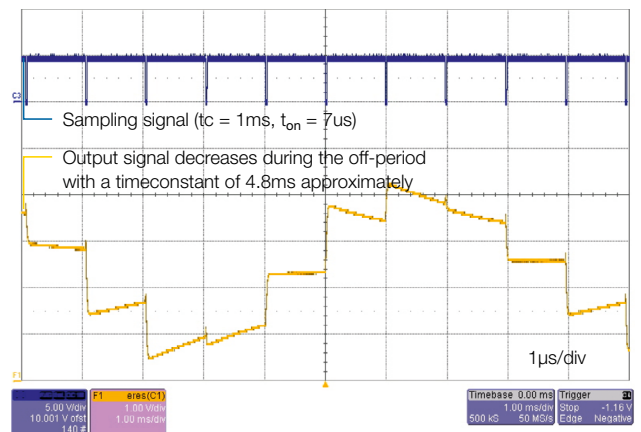

Figure 7: x_AC output amplitude decreases during sleep time.



The famous “Radar Equation” may be reduced for our K-band module to the following relation:

$$r = 0.0167 \cdot 10^{\frac{-S}{40}} \cdot \sqrt[4]{\sigma}$$

Using this formula, you get an indicative detection range of:

- 56 meters for a moving person.
- > 150 meters for a moving car

Please note, that range values also highly depend on the performance of signal processing, environment conditions (i.e. rain, fog), housing of the module and other factors.

INTEGRATORS INFORMATION

Installation Instruction

Mechanical enclosure

It is possible to hide the sensor behind a so called radome (short for radar dome) to protect it from environmental influences or to simply integrate it in the case of the end product. A radar sensor can see through different types of plastic and glass of any colour as long as it is not metallized. This allows for a very flexible design of the housing as long as the rules below are observed.

- Cover must not be metallic.
- No plastic coating with colors containing metallic or carbon particles.
- Distance between cover and front of Radar sensor should be $\geq 6.2\text{mm}$
- Cover thickness is very important and depends on the used material. Examples can be found in the application note „AN-03-Radome“.
- Vibrations of the Radar antenna relatively to the cover should be avoided, because this generates signals that can trigger the output.
- The cover material can act as a lens and focus or disperse the transmitted waves. Use a constant material thickness within the area used for transmission to minimize the effect of the radome to the radiated antenna pattern.



Detailed information about the calculation and thickness for different cover materials can be found in the application note “AN-03-Radome”.

United States (FCC) and Canada (ISED)

This module has been granted modular approval for fixed and/or mobile applications by FCC and ISED.

Testing for the modular approval has been performed in CW mode with an open VCO input. This setup can easily be used by the customer for certification purposes.

This module meets the title 47 of the Code of Federal Regulations, part 15 section 15.245 for intentional radiators operating in the 24.075 to 24.175 GHz band.



Modification to this product will void the users' authority to operate this equipment.



The OEM integrator is responsible for the final compliance to any other FCC rules that apply to the host not covered by the modular transmitter grant of certification.

Labelling and user information requirements

If the label of the module is not visible from the outside of the end product, it must include the following texts on the label of the host product:

FCC Contains FCC ID: 2ASYV-K-MC1
ISED Contains IC: 24358-KMC1

In addition to marking the product with the appropriate ID's, the end product shall bear the following statement in a conspicuous location on the label or alternatively in the user manual:

This device complies with Part 15 of the FCC Rules and with Industry Canada licence-exempt RSS standard(s). Operation is subject to the following two conditions: (1) this device may not cause harmful interference, and (2) this device must accept any interference received, including interference that may cause undesired operation.

Le présent appareil est conforme aux CNR d'Industrie Canada applicables aux appareils radio exempts de licence. L'exploitation est autorisée aux deux conditions suivantes: (1) l'appareil ne doit pas produire de brouillage, et (2) l'appareil doit accepter tout brouillage radioélectrique subi, même si le brouillage est susceptible d'en compromettre le fonctionnement.

RF Exposure

The radiated output power of the device is far below the FCC radio frequency exposure limits. Nevertheless, the device should be used in such a manner that the potential for human contact during normal operation is minimized.

Europe (CE-RED)

This module is a Radio Equipment Directive assessed radio module that is CE compliant and have been manufactured and tested with the intention of being integrated into a final product.

According to the RED every final product that includes a radio module is also a radio product which falls under the scope of the RED. This means that OEM and host manufacturers are ultimately responsible for the compliance of the host and the module. The final product must be reassessed against all of the essential requirements of the RED before it can be placed on the EU market. This includes reassessing the module for compliance against the following RED articles:

- Article 3.1(a): Health and safety
- Article 3.1(b): Electromagnetic compatibility (EMC)
- Article 3.2: Efficient use of radio spectrum (RF)



As long as a harmonized standard listed in the OJEU can be used to demonstrate conformity in accordance with Article 3.2 of the RED, it is possible to carry out the CE certification in self-declaration without the involvement of a notified body.

The K-MC1 shows compliance against the Article 3.2 by the use of the standard EN 300 440 which is a harmonized standard listed in the OJEU, what gives the possibility to show conformity by internal production control.

An OEM integrator can show compliance to article 3.1(a) and 3.1(b) for the final product by doing internal or external tests and following the Module A (Annex II of the RED) assessment procedure. To show compliance against article 3.2 it is possible to reuse the assessment of the K-MC1 as long as it is the only radio module in the final product or if the integrator can guarantee that only one radio module is operating at the same time. Test reports of the K-MC1 are available on request.



The ETSI guide EG 203 367 provides detailed guidance on the application of harmonized standards to multi-radio and combined equipment to demonstrate conformity.

RF Exposure Information (MPE)

This device has been tested and meets applicable limits for Radio Frequency (RF) exposure. A detailed calculation to show compliance to the RED Article 3.1(a) is available on request.

Simplified DoC Statement

Hereby, RFbeam Microwave GmbH declares that the radio equipment type K-MC1 is in compliance with Directive 2014/53/EU. The declaration of conformity may be consulted at www.rfbeam.ch.

ORDER INFORMATION

Figure 8: Ordering number structure

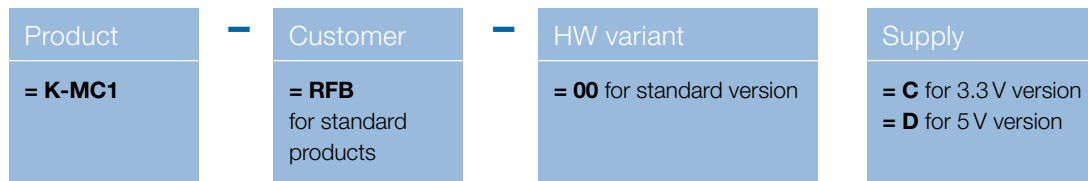

Table 2: Available ordering numbers

Ordering number	Description
K-MC1-RFB-00C	Standard K-MC1, 3.3V version
K-MC1-RFB-00D	Standard K-MC1, 5V version

DATASHEET REVISION HISTORY

08/2007 – Revision A:	initial release
10/2008 – Revision B:	Replaced Fig. 2: Mechanical dimensions Added chapter counting instruction
11/2009 – Revision C:	Operating temperature corrected to +80°C
12/2009 – Revision D:	VCO sensitivity corrected to 22MHz/V
07/2011 – Revision E:	Adapted to new hardware Revision G, valid from lot # L1114
11/2018 – Revision F:	Changed footer to new address
11/2018 – Revision G:	Changed typical value for VCO_In
11/2019 – Revision H:	Changes in specifications because of redesigned module
05/2021 – Revision I:	Added integrators information
11/2022 – Revision J:	Added FCC/ISED statement