

K-MD7

digital radar transceiver

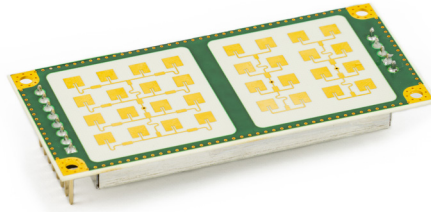

Features

- › Small and low cost digital 24 GHz traffic radar sensor
- › Measures speed, direction, distance and angle of moving objects
- › Perfect for speed signs or simple traffic counting applications
- › Maximum speed range of 200 km/h and distance range of 300m
- › Typical detection distance of 50m for persons and 150m for cars
- › Multi-target tracking for up to 8 moving objects
- › Target list output over serial UART interface
- › Pulsed FSK signal processing to lower power consumption
- › Integrated bootloader for firmware update
- › Wide operating voltage range of 3.2 to 5.5V
- › 34 x 30 degree antenna beam pattern

Description

The K-MD7 is an evolution of the successful K-LD7 with a narrower antenna beam and enhanced processing power. This allows for higher detection distances and tracking of up to 8 objects to a maximum unambiguous range of 300m. The serial interface features the possibility to read out a target list with speed, direction, distance and angle information of all moving objects in front of the sensor or to digitally configure the sensors detection parameters.

There is no need to write own signal processing algorithms or handle small and noisy signals. A small footprint of 70 x 32 x 13.5 mm gives maximum flexibility in the product development process. For fast prototyping an evaluation kit (K-MD7-EVAL) is available which features powerful signal visualization on a PC.

Block Diagram

Figure 1: **Block diagram**

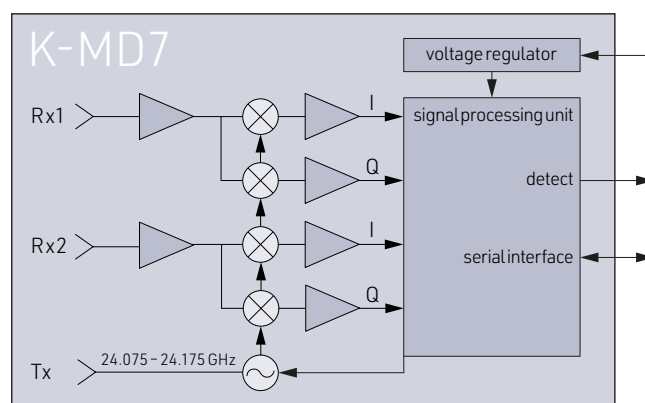

Characteristics

Parameter	Conditions / Notes	Symbol	Min	Typ	Max	Unit
Operating conditions						
Supply voltage		V_{cc}	3.2		5.5	V
RMS current	Depending on speed range setting	I_{cc}	55		105	mA
Peak current		I_{pp}		180	250	mA
Operating temperature		T_{op}	-40		+85	°C
Storage temperature		T_{st}	-40		+105	°C
Transmitter						
Transmitter frequency	$T_{amb} = -40^{\circ}\text{C} \dots +85^{\circ}\text{C}$	f_{TX}	24.075		24.175	GHz
Frequency drift vs. temperature		Δf_{TX}		0.6		MHz/°C
Antenna gain	$f_{TX} = 24.125\text{GHz}$	G_{TXAnt}		12.2		dBi
Output power	EIRP	P_{TX}			20	dBm
Spurious emissions	According to ETSI 300 440	P_{Spur}		-30		dBm
Receiver						
LNA gain		G_{LNA}		19		dB
Mixer conversion loss	$f_{IF} = 1\text{kHz}$	D_{mixer}		10		dB
Antenna gain	$f_{TX} = 24.125\text{GHz}$	G_{RXAnt}		9.8		dBi
Receiver sensitivity	$f_{IF} = 500\text{Hz}$, $B = 1\text{kHz}$, $S/N = 6\text{dB}$	P_{RX}		-104.2		dBm
Overall sensitivity	$f_{IF} = 500\text{Hz}$, $B = 1\text{kHz}$, $S/N = 6\text{dB}$	D_{system}		-148.8		dBc
Detection distance	$= 1\text{ m}^2$ (Person)	R		50		m
Signal Processing						
Modulation				FSK		
Velocity processing				512 point complex FFT		
Speed range	Max value adjustable	r_{speed}	0.5		200	km/h
Speed resolution	Depending on speed range setting	Δr_{speed}	0.2		0.8	km/h
Distance range	Max value adjustable	$r_{distance}$	1		300	m
Distance resolution	Depending on distance range setting	$\Delta r_{distance}$	1		3	m
Angular resolution		Δr_{angle}		1		deg
Tracking range		$r_{tracking}$	1		300	m
Antenna						
TX Horizontal -3dB beam width	E-Plane	$W_{\phi TX}$		30		°
TX Vertical -3dB beam width	H-Plane	$W_{\theta TX}$		30		°
RX Horizontal -3dB beam width	E-Plane	$W_{\phi RX}$		46		°
RX Vertical -3dB beam width	H-Plane	$W_{\theta RX}$		30		°
Horiz. side lobe suppression		D_{ϕ}	-12	-20		dB
Vertical side lobe suppression		D_{θ}	-12	-20		dB
Rx1 / Rx2 spacing		l		12.446		mm
Interface						
Digital output high level voltage		$V_{OH@8mA}$	2.4		3	V
Digital output low level voltage		$V_{OL@8mA}$	0		0.4	V
Digital output high level voltage		$V_{OH@20mA}$	1.7		3	V
Digital output low level voltage		$V_{OL@20mA}$	0		1.3	V
Digital input high level voltage		V_{IH}	1.7		4	V
Digital input low level voltage		V_{IL}	-0.3		1.3	V
Digital I/O source/sink current		I_{OH}, I_{OL}	-20		20	mA
Body						
Outline dimensions				70 × 32 × 13.5		mm ³
Weight				11		g
Connector				3pin 2.54mm / 8pin 2.54mm		
ESD rating						
Electrostatic discharge	Human body model class 2	V_{ESD}			2000	V

Table of contents

1	Antenna Diagram Characteristics	4
2	Pin configurations and functions	4
3	Theory of Operation	5
	3.1 Overview	5
	3.2 Processing	5
	3.3 Speed and direction measurement	6
	3.4 Distance measurement	6
	3.5 Angle measurement	6
	3.6 Raw targets and tracking filter	7
4	Application information	8
	4.1 Host driven operation	8
	4.2 Radar settings	8
	4.3 Detection settings	10
5	Instruction set description	11
	5.1 Hardware Layer	11
	5.2 Communication Layer	11
	5.3 Presentation Layer	12
	5.4 Application	13
	5.5 Bootloader	18
6	Integrators information	20
	6.1 Installation Instruction	20
	6.2 Europe (CE-RED)	21
	6.3 United States (FCC) and Canada (ISED)	22
7	Outline Dimensions	23
8	Order information	23
9	Revision history	23

1 Antenna Diagram Characteristics

This diagram shows module sensitivity in both azimuth and elevation directions. It incorporates the transmitter and receiver antenna characteristics.

Figure 2: Overall antenna diagram

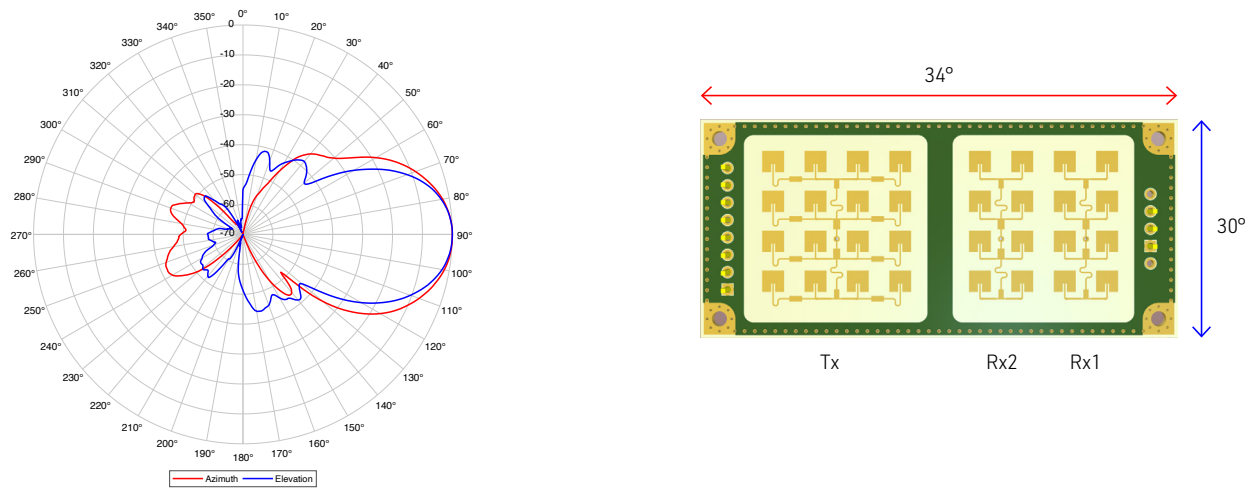

2 Pin Configurations and Functions

Figure 3: Pin configuration

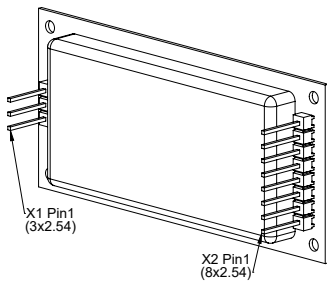

Table 1: Pin function description

Connector	Pin. No.	Name	Description
X1	1 - 3	Mounting	These pins are for mounting only.
			Leave these pins floating and do not connect them to any potential.
X2	1	GND	Ground pin
	2	Detection out	Digital detection output. Goes to high if in minimum one tracked target is inside of the defined detection zone.
		The detection area and other parameters of the detection algorithm can be easily changed over the instruction set.	
	3	VCC	Power supply pin (3.2 to 5.5V)
	4	RX	Serial interface RX input
	5	TX	Serial interface TX output
	6	Digital IO 1	Reserved for future use, do not connect
	7	Digital IO 2	Reserved for future use, do not connect
	8	Digital IO 3	Reserved for future use, do not connect

3 Theory of Operation

3.1 Overview

The K-MD7 is a Doppler radar sensor and consists of an analogue RF frontend and a powerful signal processor with tracking and a fully digital serial interface. The RF frontend features one transmitter with a modulation input and two I/Q receivers. The signal processing unit modulates the frontend with a frequency step (FSK modulation) and samples the analogue I/Q Doppler signals for both transmit frequencies and for both receiving antennas. The processing of this sampled data allows the measurement and tracking of speed, direction, distance and angle of moving objects in the front of the sensor.

3.2 Processing

The processing of the K-MD7 uses different processing stages to measure and track the speed, direction, distance and angle of moving targets. The last stage implements a configurable detection zone which signals a detection over a digital output. To get the full control in an application it is possible to read out the data of each processing step over the serial interface.

Table 4: **Signal processing workflow**

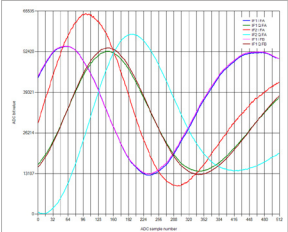
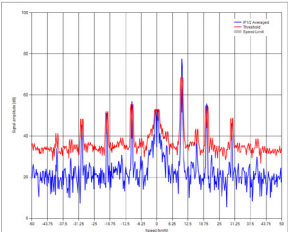
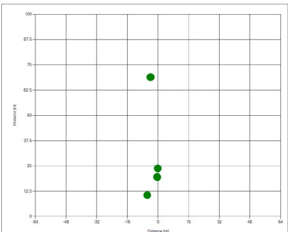
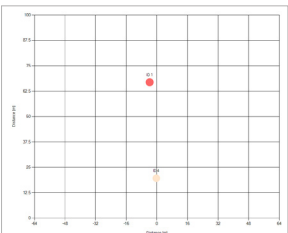
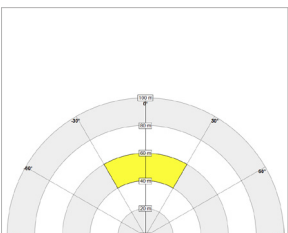
	<p>Raw ADC data (RADC)</p> <ul style="list-style-type: none"> › Samples I/Q ADC data of receiver Rx1 and Rx2 for frequency A › Samples I/Q ADC data of receiver Rx1 for frequency B
	<p>Raw FFT data (RFFT)</p> <ul style="list-style-type: none"> › Calculates the complex FFT from the I/Q ADC data of Rx1 and Rx2 for frequency A › Averages the two complex FFT's › Adds the threshold line to the RFFT data › Includes speed and direction filters
	<p>Raw target data (PDAT)</p> <ul style="list-style-type: none"> › Search all targets above a threshold in the FFT › Calculates the speed, direction, distance and angle of each target › Generates up to 24 raw targets for the PDAT target list
	<p>Tracking data (TDAT)</p> <ul style="list-style-type: none"> › Cluster and track the dominant raw targets › Filter out interferences › Predicts temporary lost objects › Can track up to 8 different targets
	<p>Detection zone</p> <ul style="list-style-type: none"> › Generates a detection if in minimum one tracked target is in a detection zone › Size of detection zone is configurable

3.3 Speed and direction measurement

Every moving object in front of the sensor generates a Doppler frequency at the analogue outputs of the RF frontend. This Doppler frequency is proportional to the speed of the object. Moving direction is defined by the phase shift between the I/Q signals.

The K-MD7 calculates the speed and the direction for all raw targets. The direction is represented by the sign of the speed. A positive speed represents a receding and a negative speed an approaching movement.

The calculated speed is only correct if the movement of the object is radial to the sensor. If the movement is tangential the speed needs to be compensated by the angle of the movement compared to the sensor.

$$v_{real} = \frac{v_{measured}}{\cos(\alpha)} \quad [km/h]$$

Figure 5: **Tangential speed compensation**

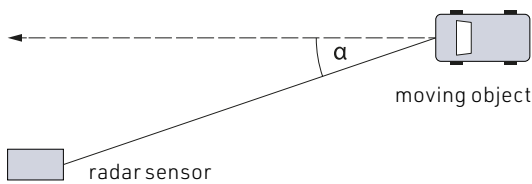

3.4 Distance measurement

The distance measurement is based on the FSK principle. The signal processing unit quickly changes between two discrete RF frequencies and measures the ADC values for both transmitting frequencies. After the detection of all raw targets above the threshold, the distance for each target is calculated based on the phase difference in both ADC signals.

3.5 Angle measurement

The angle measurement is based on the angle of arrival principle. After the detection of all raw targets above the threshold, the angle for each target is calculated based on the phase difference between the two receiving channels.

The angle is calculated in degree and valid between +/- 30°. If an object has an angle of zero it is directly in front of the sensor. A positive or negative angle defines if the target is more on the right or left side of the sensor.

⚠ Any objects outside the valid angular range will be attenuated due to the narrow antenna beam of the sensor. If a strong reflector is in the near field of the sensor, but outside the unambiguous angle range, it may produce a RAW target with incorrect angle information.

Figure 6: **Positive and negative angle definition**

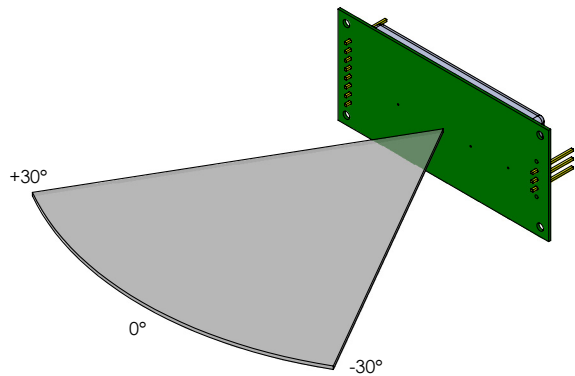

3.6 Raw targets and tracking filter

A real object generates not only one raw target point. A car for example generates several raw target points with different speeds and different distances created by the size of the car and the wheels. This generates a so called point cloud of different raw targets from one object. Depending on the environment where the sensor is used it will also see more or less reflexions generated by the moving object. The number of raw targets can be controlled by adjusting the threshold offset which is described in more detail in chapter [Threshold offset on page 9](#) or by using a speed or direction filter.

To get a more usable output the sensor features a tracking filter to cluster and track the dominant targets based on the raw targets. The filter includes a suppression of reflexions, vibrations and interferences and can also predict temporary lost targets which generates a smooth output.

The tracking filter can be adapted to various applications via the parameters Tracking filter type which is described in more detail in chapter [Tracking on page 9](#). information.

Figure 7: **RAW targets vs. tracked targets**

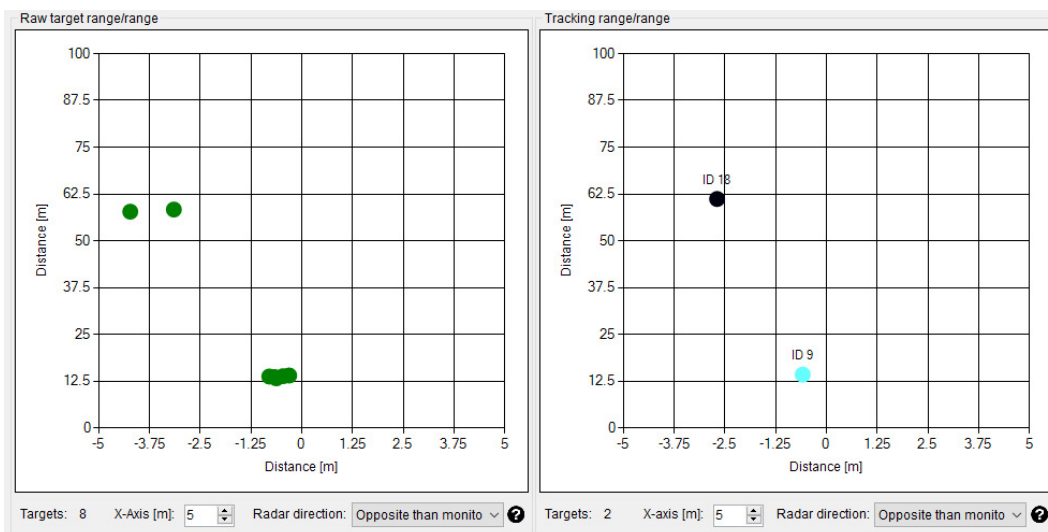

4 Application Information

4.1 Host driven operation

With a connection of the serial interface to a host (for example MCU or PC) it is possible to read out the processing data (RADC, RFFT, PDAT and TDAT) and control all the parameters of the sensor. Optionally it is possible to connect the digital output of the sensor to an input on the host to trigger the host if the sensor generates a valid detection. This is the recommended use case and allows the user to optimize the sensor easily for different applications.

Figure 8: **MCU or PC connection example**

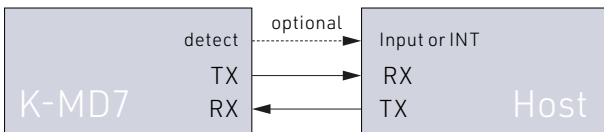

4.2 Radar settings

The K-MD7 features different parameters to adjust the functionality of the sensor to the needs of different applications. All parameters are stored in the radar parameter structure which can be read out and written over the serial interface. The structure and the serial protocol are described in the [chapter Instruction Set Description on page 11](#).

It is very important to set the distance and speed range settings to values which are matching with the distance and speed of the expected targets in the detection area of the sensor.

For example, if the goal is to measure objects in the 100m distance and 50km/h speed range, but cars are moving at 150m with 150km/h, the 200m distance range and 200km/h speed range setting must be used or the threshold offset needs to be increased until the cars are no longer visible in the raw targets.

Wrong settings can generate false sensor outputs. It is possible that strong targets outside the configured distance or speed range can create faulty targets.

4.2.1 Distance range

The distance range parameter defines the maximum unambiguous distance measurement of the sensor. For a lower maximal distance range, the range resolution is better but if the distance of a measured target is higher than the current distance range setting it can generate wrong measurements. Hence it is very important to set the distance range to a setting where targets are expected.

Table 2: **Distance range settings**

Max. range [m]	Range resolution [m]
100	1
200	2
300	3

An approach to work with a lower maximum distance range is to change the sensor orientation to get a field of view without moving objects above the maximal distance range or to increase the threshold offset (described in the [chapter Threshold offset on page 9](#)) to reduce the sensitivity of the sensor.

4.2.2 Speed range

The speed range parameter defines the maximum unambiguous speed measurement of the sensor. For a lower maximal speed range, the speed resolution is better and the current consumption is smaller but if the speed of a measured target is higher than the current speed range setting it can generate wrong measurements. Therefore it is very important to set the speed range to a setting where targets are expected.

Table 3: **Speed range settings**

Max. speed [km/h]	Speed resolution [km/h]	Typ. frame duration [ms]	Typ. Supply current [mA]
50	0.2	114	55
100	0.4	57	72
200	0.8	29	105

An approach to work with a lower maximum speed is to change the sensor orientation to get a field of view without moving objects above the maximal speed range or to increase the threshold offset (described in the chapter [Threshold offset on page 9](#)) to reduce the sensitivity of the sensor.

 To read out data intensive messages like RADC and RFFT it is recommended to work with the highest baud rate. If the readout time of the requested data is higher than the typical frame duration it is not possible to read out the frames in real time. By checking the frame number in the DONE message, it is possible to validate real time readout.

4.2.3 Threshold offset

The threshold offset is adjustable and defines the distance in dB between the noise floor of the raw FFT data and the threshold line. The processing in the K-MD7 searches for raw targets that are above this threshold line. The smaller the offset the more sensitive the sensor will be. A higher offset will reduce the sensitivity.

Figure 9: **Low vs. high threshold offset**

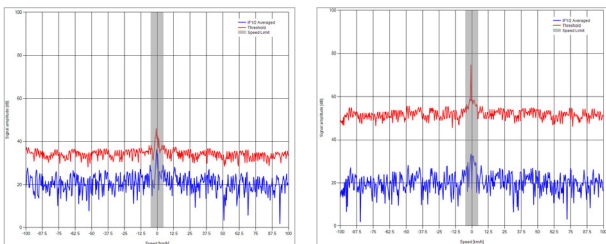

4.2.4 Tracking filter

The tracking filter can track up to 8 different targets and has the option to change its behaviour over a parameter in the instruction set.

 The implemented tracking filter is optimized for traffic applications and hence the output does potentially not match your application requirements. RFbeam offers the possibility to customize the tracker to your needs. Do not hesitate to contact us for an appropriate quote.

Table 4: **Tracking filter types**

Filter type	Description
Standard	Standard filter type to track multiple cars on a street
Fast detection	Enables a faster detection of the target with the disadvantage to reduce the immunity against reflexions and other interferences.
Long visibility	Filter with a high immunity against interferences and a high prediction of temporary lost targets

4.2.5 Base frequency

There are three channels available to adjust the base transmit frequency of the sensor. This can be useful if multiple sensors are transmitting in the same area with the same base frequency to suppress the generated interferences that can occur in such an environment

4.3 Detection settings

4.3.1 Target generation filter

The generation of targets in the K-MD7 can be filtered based on a set of adjustable parameters to optimize the sensor for different applications. The parameters are all located in the radar parameter structure which is described in detail in chapter [Parameter structure on page 14](#).

Table 5: **Target generation filter parameters**

Parameter name	Description
Min. / max. detection speed	Used to filter out slow or fast targets. PDAT Raw targets are only generated if the speed of the object is between the minimum and maximum detection speed limit.
Detection direction	Used to limit the target generation by its direction. It is possible to filter out approaching or receding targets or allow a detection for both directions.

4.3.2 Detection zone filter

The K-MD7 features a configurable detection zone filter which switches the detection output to high as soon as at least one TDAT target is within the defined zone. This function can be used, for example, to wake up the host or an external display when a valid target is detected.

Table 6: **Detection zone filter parameters**

Parameter name	Description
Min. / max. detection zone distance	Used to limit the detection zone to a minimum and maximum distance.
Min. / max. detection zone angle	Used to limit the detection zone to a minimum and maximum angle.

 The detection zone is only adjustable inside of the unambiguous angle range of +/- 30°.

Figure 10: **Detection zone visualisation**



5.3.3 Digital output

The sensor features four digital IO's on its connector. One output is used to signal if there is in minimum one tracked target within the detection zone. The remaining 3 IO's are reserved for future use or customer specific functions.

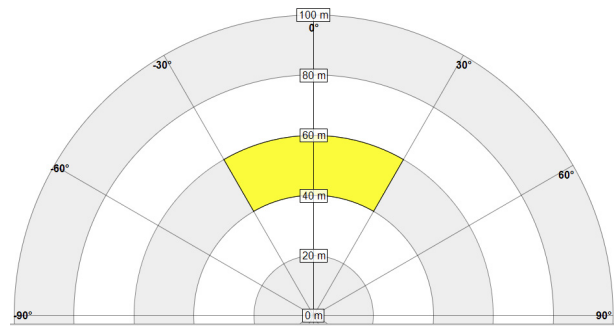
Table 7: **Functionality of detection output**

Function	Description
Detection output	Signals if there is a moving object inside of the detection zone Low -> No valid target inside the detection zone High -> In minimum one TDAT target inside the detection zone

5 Instruction Set Description

5.1 Hardware Layer

The hardware layer is based on a simple UART connection with a configurable baud rate. The sensor always starts up with its default baud rate. The default baud rate can be changed over the INIT command as described in the chapter [Connection](#) on page 12.

Table 8: **Default serial connection settings**

Parameter	Configuration
Baud rate	115200
Data bits	8
Parity	Even
Stop bits	1
Flow control	None

5.2 Communication Layer

5.2.1 Client-Server

Figure 11: **Client-Server model**

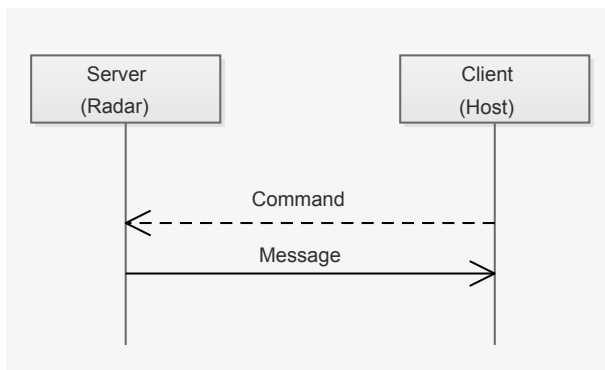

The communication is based on a client-server model. There are two types of packets transmitted. Commands are sent from client to server and messages are sent from server to client.

5.2.2 Handshaking

Figure 12: **Handshaking**

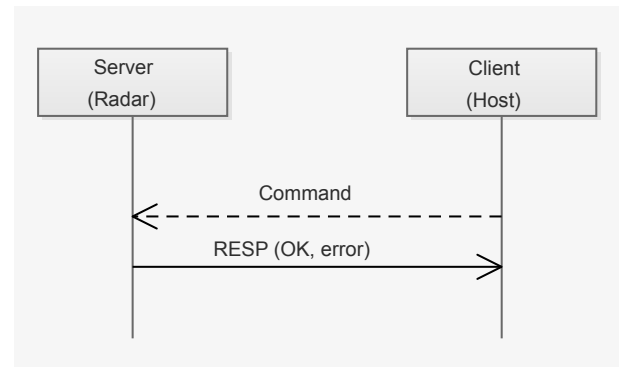

Every command sent by the client is acknowledged by the server with a response message (RESP). The response message includes an error code what delivers information data about the success or failure of the received command.

5.2.3 Connection

Figure 13: Connection

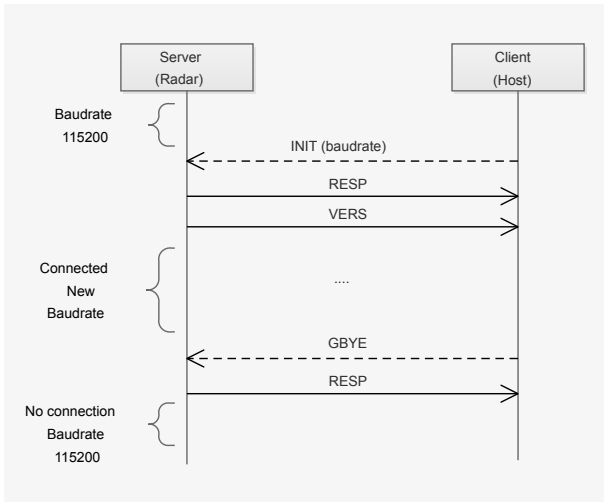

The server starts up with a default baud rate of 115200 baud. The client has to establish a connection with the INIT command where it needs to define the baud rate which will be used for the communication. After acknowledging of the INIT command by a RESP message a VERS message with a firmware string follows before the server changes the baud rate to the selected one out of the INIT command.

The firmware string of the VERS message can be used to check if the sensor has started into the application or to the bootloader. The sensor only starts into the bootloader if a jump bootloader command was sent out of the application or if there is a corrupt firmware programmed.

To disconnect, the GBYE command has to be sent by the client. After acknowledging the GBYE message the server changes back to his default baud rate.

5.3 Presentation Layer

All commands and messages sent have the format described in table below.

Table 9: Packet format

Description	Datatype	Length
Header The header describes the command or message type (e.g. INIT, RADC, ...)	ASCII character	4 Bytes
Payload Length Defines the size of the added payload. The payload length is always sent even if the payload is zero. It is sent as little endian (LSB first).	UINT32	4 Bytes
Payload The payload is message and command dependent. If the payload includes datatypes with multiple bytes (e.g. UINT16, INT32, ...) then they are sent as little endian (LSB first).	Binary data	x

5.4 Application

5.4.1 Data output

The client can request application messages from the server using a handshake or streaming mode.

In handshake mode, the client must request each message with the GNFD command, which has the disadvantage that messages can be lost if the client is too slow to send the next GNFD command within one frame.

The streaming mode allows the client to enable or disable streaming of messages via the RDOT command. The sensor then sends the enabled messages per frame in real time to the client. This only makes sense if the client can process all data fast enough.

Figure 14: **Read messages in handshake mode**

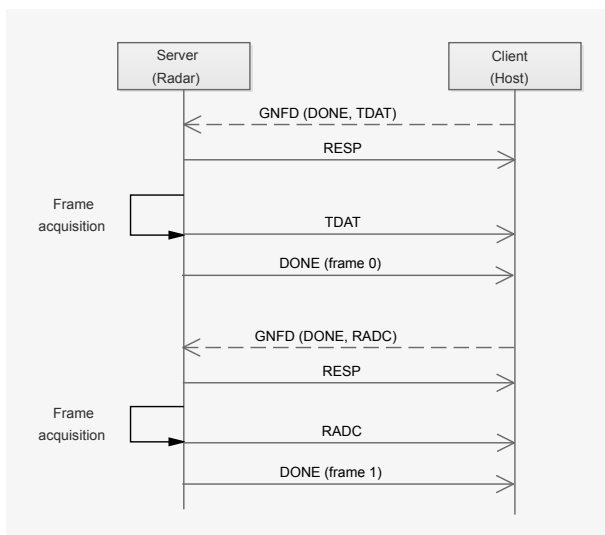
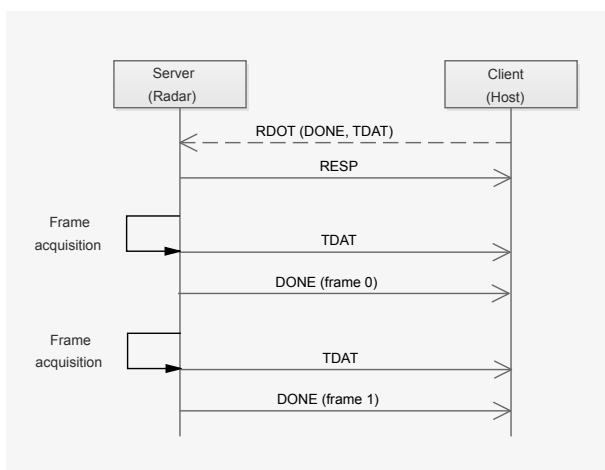

Figure 15: **Read messages in streaming mode**



5.4.2 Get and set parameter structure

The client can set every parameter with a single command. But there is also the possibility to set all parameters together within a parameter structure or read this structure out. The structure is defined in detail in the next chapter.

Figure 16: **Get parameter structure**

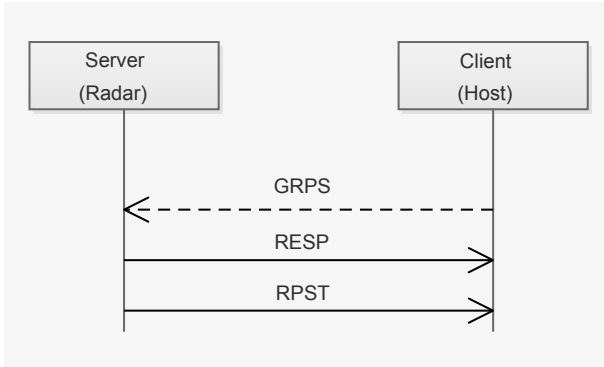
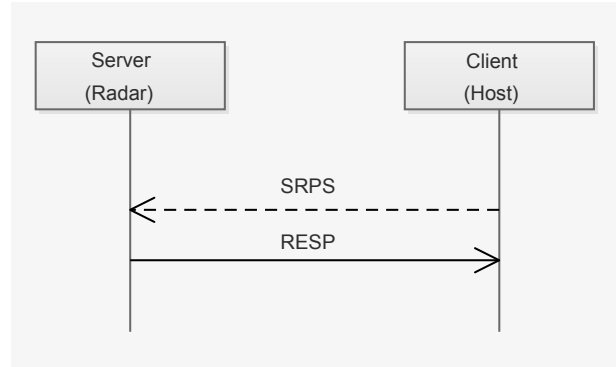

Figure 17: **Set parameter structure**



5.4.3 Parameter structure

The radar has a set of parameters what are stored in a structure. The structure can be read out by the GRPS command and set by the SRPS command. Further it is possible to change each parameter by a dedicated command.

Table 10: **Radar parameter structure**

Description	Datatype	Payload length	Payload data	Default settings
Firmware version	STRING	19	Zero-terminated String	K-MD7_APP-RFB-YYYY
Frequency channel	UINT8	1	0=Low 1=Middle 2=High	1 = Middle
Speed setting	UINT8	1	0=50km/h 1=100km/h 2=200km/h	1 = 100km/h
Range setting	UINT8	1	0=100m 1=200m 2=300m	1 = 200m
Threshold offset	UINT8	1	Minimum = 0 dB Maximum = 60 dB	12 dB
Tracking filter type	UINT8	1	0=Standard 1=Fast detection 2=Long visibility	0 = Standard
Minimum detection zone distance	UINT8	1	0-100% of range setting	40% -> 80m @ default range
Maximum detection zone distance	UINT8	1	0-100% of range setting	60% -> 120m @ default range
Minimum detection zone angle	INT8	1	-30° to +30°	-30°
Maximum detection zone angle	INT8	1	-30° to +30°	+30°
Minimum detection speed filter	UINT8	1	0-100% of speed setting	5%
Maximum detection speed filter	UINT8	1	0-100% of speed setting	100%
Detection direction filter	UINT8	1	0=Receding 1=Approaching 2=Both	2 = Both

5.4.4 Commands

The following table provides detailed information about all possible commands of the application:

Table 11: **Application commands**

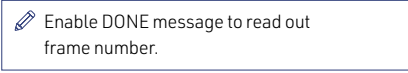
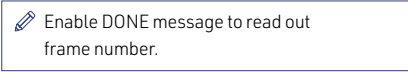
Header	Payload length	Description	Datatype	Payload data																
INIT	1	Command to start a connection with a defined baud rate.	UINT8	Baud rate in bit/s: 0=115200 1=460800 2=921600 3=2000000 4=3000000																
GNFD	1	Get next frame data request to read out application messages once. 	UINT8	Binary coded bit-field for messages: 0=disabled, 1=enabled Bit-field representation: <table border="1"> <tr> <td>7</td> <td>6</td> <td>5</td> <td>4</td> <td>3</td> <td>2</td> <td>1</td> <td>0</td> </tr> <tr> <td>X</td> <td>X</td> <td>DONE</td> <td>X</td> <td>TDAT</td> <td>PDAT</td> <td>RFFT</td> <td>RADC</td> </tr> </table> X = don't care	7	6	5	4	3	2	1	0	X	X	DONE	X	TDAT	PDAT	RFFT	RADC
7	6	5	4	3	2	1	0													
X	X	DONE	X	TDAT	PDAT	RFFT	RADC													
RDOT	1	Enable streaming messages. All enabled messages will be streamed out until a GBYE command is sent or a power cycle is performed. 	UINT8	Binary coded bit-field for messages: 0=disabled, 1=enabled Bit-field representation: <table border="1"> <tr> <td>7</td> <td>6</td> <td>5</td> <td>4</td> <td>3</td> <td>2</td> <td>1</td> <td>0</td> </tr> <tr> <td>X</td> <td>X</td> <td>DONE</td> <td>X</td> <td>TDAT</td> <td>PDAT</td> <td>RFFT</td> <td>RADC</td> </tr> </table> X = don't care	7	6	5	4	3	2	1	0	X	X	DONE	X	TDAT	PDAT	RFFT	RADC
7	6	5	4	3	2	1	0													
X	X	DONE	X	TDAT	PDAT	RFFT	RADC													
GRPS	0	Read complete radar parameter structure	-	-																
SRPS	31	Write complete radar parameter structure	STRUCT	See chapter "Parameter structure" for detailed information about the format of the data structure.																
RFSE	0	Restore factory settings	-	-																
GBYE	0	Disconnect from sensor	-	-																
RBFR	1	Set frequency channel to prevent interferences if multiple sensors are used in the same application.	UINT8	0=Low 1=Middle 2=High																
RSPI	1	Set speed setting	UINT8	0=50km/h 1=100km/h 2=200km/h																
RRAI	1	Set range setting	UINT8	0=100m 1=200m 2=300m																
THOF	1	Change threshold offset	UINT8	0-60dB																
TRFT	1	Set tracking filter type	UINT8	0=Standard 1=Fast detection 2=Long visibility																
MIRA	1	Change minimum detection zone distance	UINT8	0-100% of range setting																
MARA	1	Change maximum detection zone distance	UINT8	0-100% of range setting																
MIAN	1	Change minimum detection zone angle	INT8	-30° to +30°																
MAAN	1	Change maximum detection zone angle	INT8	-30° to +30°																
MISP	1	Set minimum detection speed filter	UINT8	0-100% of speed setting																
MASP	1	Set maximum detection speed filter	UINT8	0-100% of speed setting																
DEDI	1	Change detection direction filter	UINT8	0=Receding 1=Approaching 2=Both																
JBTL	0	Jump to bootloader	-	-																

5.4.5 Messages

The following table provides detailed information about all possible messages of the application:

Table 12: **Application messages**

Header	Payload length	Description	Datatype	Payload data		
RESP	1	Response message including an error code	UINT8	Error codes: 0=OK, no error 1=Unknown command, 2=Invalid parameter value 3=Invalid RPST version 4=Uart error (parity, framing, noise) 5=No calibration values 6=Timeout 7= Application corrupt or not programmed		
VERS	19	Application version	STRING	Version string including Null-terminator: K-MD7_APP-RFB-YYXX YY=Variant, XX=Revision		
RADC	6144	Raw ADC values <div style="border: 1px solid black; padding: 2px; width: fit-content; margin-top: 5px;">⚠ It is recommended to use the highest baud rate when reading out RADC messages</div>	STRUCT	Description	Datatype	Length
				IF1 Frequency A 512 values of I-Channel 512 values of Q-Channel	UINT16	2048
				IF2 Frequency A 512 values of I-Channel 512 values of Q-Channel	UINT16	2048
				IF1 Frequency B 512 values of I-Channel 512 values of Q-Channel	UINT16	2048
RFFT	2048	Raw FFT <div style="border: 1px solid black; padding: 2px; width: fit-content; margin-top: 5px;">⚠ It is recommended to use the highest baud rate when reading out RFFT messages</div>	STRUCT	Description	Datatype	Length
				512 spectrum points [dB x 100]	UINT16	1024
				512 threshold points [dB x 100]	UINT16	1024
PDAT	0-192	The array of detected raw targets. Max. 24 targets with 8 bytes each.	STRUCT	Description	Datatype	Length
				Distance [cm]	UINT16	2
				Speed [km/h x 100]	INT16	2
				Angle [deg x 100]	INT16	2
				Magnitude of target [dB x 100]	UINT16	2
TDAT	0-72	The array of tracked targets. Max. 8 targets with 9 bytes each.	STRUCT	Description	Datatype	Length
				Distance [cm]	UINT16	2
				Speed [km/h x 100]	INT16	2
				Angle [deg x 100]	INT16	2
				Magnitude of target [dB x 100]	UINT16	2
				Tracking channel ID	UINT8	1
DONE	4	Frame done information with frame number	UINT32	Frame number since reset.		
RPST	31	Radar parameter structure	STRUCT	See chapter "Parameter structure" for details		

5.4.6 Communication example

Figure 18: **Example INIT command with 115200 baud**

host to radar	Header: INIT				Length: 1 Byte				Payload 1 Byte: value 0 = 115200 baud			
	0x49	0x4E	0x49	0x54	0x01	0x00	0x00	0x00	0x00			
radar to host	Header: RESP				Length: 1 Byte				Payload 1 Byte: value 0 = OK			
	0x52	0x45	0x53	0x50	0x01	0x00	0x00	0x00	0x00			
radar to host	Header: VERS				Length: 19 Byte				Payload 19 Byte: Firmware string			
	0x56	0x45	0x52	0x53	0x13	0x00	0x00	0x00	For example: K-MD7_APP-RFB-0100 if connected to application or K-MD7_BTL-RFB-0100 for bootloader			

Figure 19: **Example read out TDAT message with GNFD command**

host to radar	Header: GNFD				Length: 1 Byte				Payload 1 Byte: value 8 = only TDAT enabled							
	0x47	0x4E	0x46	0x44	0x01	0x00	0x00	0x00	0x08							
radar to host	Header: RESP				Length: 1 Byte				Payload 1 Byte: value 0 = OK							
	0x52	0x45	0x53	0x50	0x01	0x00	0x00	0x00	0x00							
radar to host	Header: TDAT				Length: 9 Byte				Payload 9 Byte: Only one TDAT target detected							
	0x54	0x44	0x41	0x54	0x09	0x00	0x00	0x00	0xF2	0x2B	0x97	0xFF	0x2F	0x07	0x15	0x18

Figure 20: **Example GBYE message**

host to radar	Header: GBYE				Length: 0 Byte							
	0x47	0x42	0x59	0x45	0x00	0x00	0x00	0x00				
radar to host	Header: RESP				Length: 1 Byte				Payload 1Byte: value 0 = OK			
	0x52	0x45	0x53	0x50	0x01	0x00	0x00	0x00	0x00			

Table 13: **Example TDAT structure conversion**

Description	TDAT payload LSB first		Value	Datatype	Conversion	Result
Distance [cm]	0xF2	0x2B	0x2BF2	UINT16	-	11250 cm
Speed [km/h x 100]	0x97	0xFF	0xFF97	INT16	/100	-1.05 km/h
Angle [deg x 100]	0x2F	0x07	0x072F	INT16	/100	18.39 deg
Magnitude of target [dB x 100]	0x15	0x18	0x1815	UINT16	/100	61.65 dB
Tracking channel ID	0x17	-	0x17	UINT8	-	ID 23

5.5 Bootloader

The bootloader can be invoked by sending a „Jump to bootloader“ command from the application. After receiving the bootloader jump command, the sensor restarts, stays in the bootloader and waits for a new connection via an INIT command.

The host receives a VERS message back after a successful INIT command, which can be used to check if the sensor has started into the bootloader.

Figure 21: Jump to bootloader out of the application

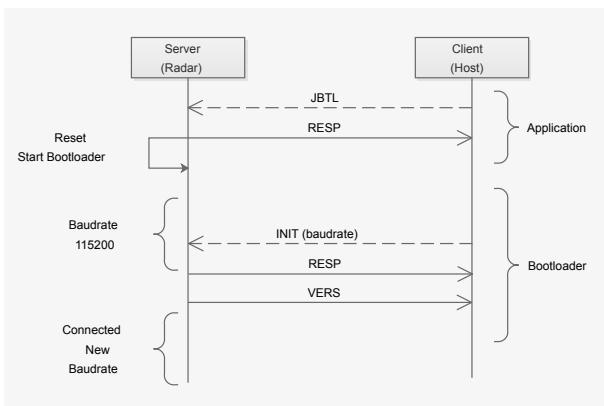

In the next step, the host must send the complete firmware binary (provided by RFbeam Microwave) in packets of maximum 2048 bytes to the radar sensor using the WMEM command.

After successfully writing the binary file, a GBYE command must be sent to complete the update. The corresponding RESP message return a feedback with the error code whether the update was successful or not.

The sensor then restarts and the host can establish a new connection with an INIT command. The VERS message sent during this process provides information about the new firmware version.

Figure 22: Successful firmware update sequence

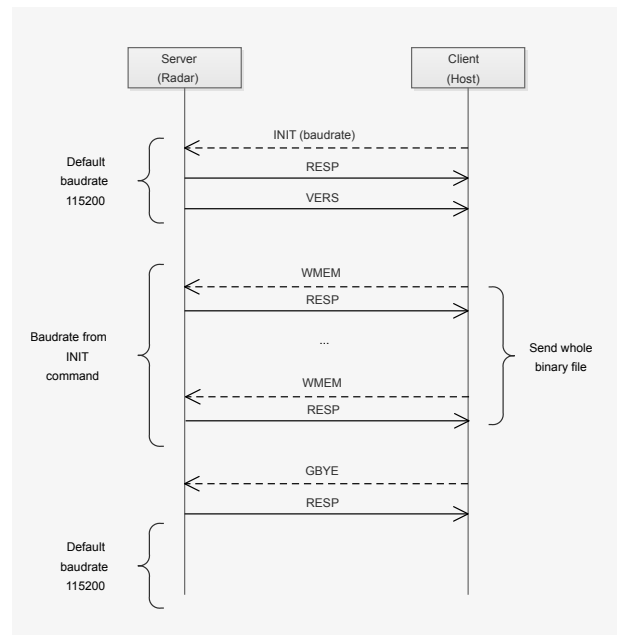

5.5.1 Commands

The following table provides detailed information about all possible commands of the bootloader:

Table 14: **Bootloader commands**

Header	Payload length	Description	Datatype	Payload data												
INIT	1	Command to start a connection with a defined baud rate.	UINT8	Baud rate in bit/s: 0=115200 1=460800 2=921600 3=2000000 4=3000000												
GBYE	0	Disconnect	-	-												
WMEM	9 to 2056	Write a flash memory page to a defined memory address. <div style="border: 1px solid black; padding: 2px; width: fit-content;">  Use only firmware update files provided by RFbeam Microwave. </div>	STRUCT	Each page write command needs the following data structure: <table border="1"> <thead> <tr> <th>Byte</th> <th>Length</th> <th>Description</th> </tr> </thead> <tbody> <tr> <td>0-3</td> <td>4</td> <td>Relative memory address in little endian (LSB first). Starts at 0x000000 and must be a multiple of 0x800 with a maximum of 0x06E000.</td> </tr> <tr> <td>4-7</td> <td>4</td> <td>Data length of the binary data. The length needs to be between 1 and 2048.</td> </tr> <tr> <td>8-2055</td> <td>1 to 2048</td> <td>Binary application data</td> </tr> </tbody> </table>	Byte	Length	Description	0-3	4	Relative memory address in little endian (LSB first). Starts at 0x000000 and must be a multiple of 0x800 with a maximum of 0x06E000.	4-7	4	Data length of the binary data. The length needs to be between 1 and 2048.	8-2055	1 to 2048	Binary application data
Byte	Length	Description														
0-3	4	Relative memory address in little endian (LSB first). Starts at 0x000000 and must be a multiple of 0x800 with a maximum of 0x06E000.														
4-7	4	Data length of the binary data. The length needs to be between 1 and 2048.														
8-2055	1 to 2048	Binary application data														

5.5.2 Messages

The following table provides detailed information about all possible messages of the bootloader:

Table 15: **Bootloader messages**

Header	Payload length	Description	Datatype	Payload data
RESP	1	Response message including an error code.	UINT8	Error codes: 0=OK, no error 1=Unknown command, 2=Invalid parameter value 3=Invalid RPST version 4=Uart error (parity, framing, noise) 5=No calibration values 6=Timeout 7=Application corrupt or not programmed
VERS	19	Bootloader version	STRING	Version string including Null-terminator: K-MD7_BTL-RFB-YYXX YY=Variant, XX=Revision

6 Integrators Information

6.1 Installation Instruction

6.1.1 Mechanical enclosure

It is possible to hide the sensor behind a so called radome (short for radar dome) to protect it from environmental influences or to simply integrate it in the housing of the end product. A radar sensor can see through different types of plastic and glass of any colour as long as it is not metallized. This allows for a very flexible design of the housing as long as the rules below are observed.

- › Cover must not be metallic.
- › No plastic coating with colours containing metallic or carbon particles.
- › Distance between cover and front of Radar sensor should be $\geq 6.2\text{mm}$
- › Cover thickness is very important and depends on the used material. Examples can be found in the application note „AN-03-Radome“.
- › Vibrations of the Radar antenna relatively to the cover should be avoided, because this generates signals that can trigger the output
- › The cover material can act as a lens and focus or disperse the transmitted waves. Use a constant material thickness within the area used for transmission to minimize the effect of the radome to the radiated antenna pattern.



Detailed information about the calculation and thickness for different cover materials can be found in the application note "AN-03-Radome".

6.2 Europe (CE-RED)

This module is a Radio Equipment Directive assessed radio module that is CE compliant and have been manufactured and tested with the intention of being integrated into a final product.

According to the RED every final product that includes a radio module is also a radio product which falls under the scope of the RED. This means that OEM and host manufacturers are ultimately responsible for the compliance of the host and the module. The final product must be reassessed against all of the essential requirements of the RED before it can be placed on the EU market. This includes reassessing the module for compliance against the following RED articles:

- › Article 3.1(a): Health and safety
- › Article 3.1(b): Electromagnetic compatibility (EMC)
- › Article 3.2: Efficient use of radio spectrum (RF)

The RED knows different conformity assessment procedures to show compliance against the essential requirements (See RED Guide, chapter 2.6b). As long as the radio module can show compliance to Article 3.2 by the use of a harmonized standard, which is listed in the official journal of the EU (OJEU), it is not necessary to do an EU type examination for the final radio product by a notified body. In this case it is possible to demonstrate conformity according to the essential requirements of the RED by using Module A (Annex II of the RED), which allows to show conformity by internal production control.

 As long as a harmonized standard listed in the OJEU can be used to demonstrate conformity in accordance with Article 3.2 of the RED, it is possible to carry out the CE certification in self-declaration without the involvement of a notified body.

The K-MD7 shows compliance against the Article 3.2 by the use of the standard EN 300 440 which is a harmonized standard listed in the OJEU, what gives the possibility to show conformity by internal production control.

An OEM integrator can show compliance to article 3.1(a) and 3.1(b) for the final product by doing internal or external tests and following the Module A (Annex II of the RED) assessment procedure. To show compliance against article 3.2 it is possible to reuse the assessment of the K-MD7 as long as it is the only radio module in the final product or if the integrator can guarantee that only one radio module is operating at the same time. Test reports of the K-MD7 are available on request.

 The ETSI guide EG 203 367 provides detailed guidance on the application of harmonized standards to multi-radio and combined equipment to demonstrate conformity.

6.2.1 RF Exposure Information (MPE)

This device has been tested and meets applicable limits for Radio Frequency (RF) exposure. A detailed calculation to show compliance to the RED Article 3.1(a) is available on request.

6.2.2 Simplified DoC Statement

Hereby, RFbeam Microwave GmbH declares that the radio equipment type K-MD7 is in compliance with Directive 2014/53/EU. The declaration of conformity may be consulted at www.rfbeam.ch.

6.3 United States (FCC) and Canada (ISED)

Testing for the modular approval has been performed using the 100 m range and 200 km/h setting on all available frequency channels. This represents the maximum TX emission configuration with the maximum occupied bandwidth and duty cycle. The OEM integrator is responsible for determining whether the host product requires additional testing or certification.

This module complies with the applicable requirements of 47 CFR Part 15.245 for operation in the 24.075 GHz to 24.175 GHz band.

 Modification to this product will void the user's authority to operate this equipment.

 The OEM integrator is responsible for final compliance with any other FCC and ISED requirements applicable to the host product that are not covered by the modular transmitter grant of certification.

6.3.1 Labelling and user information requirements

If the module label is not visible when installed in the end product, the host product must bear the following label:

FCC: Contains FCC ID: 2ASYV-K-MD7
ISED: Contains IC: 24358-KMD7

In addition to marking the product with the appropriate ID's, the end product shall bear the following statement in a conspicuous location on the label or alternatively in the user manual:

This device complies with Part 15 of the FCC Rules and with Industry Canada licence-exempt RSS standard(s). Operation is subject to the following two conditions: (1) this device may not cause harmful interference, and (2) this device must accept any interference received, including interference that may cause undesired operation.

Le présent appareil est conforme aux CNR d'Industrie Canada applicables aux appareils radio exempts de licence. L'exploitation est autorisée aux deux conditions suivantes: (1) l'appareil ne doit pas produire de brouillage, et (2) l'appareil doit accepter tout brouillage radioélectrique subi, même si le brouillage est susceptible d'en compromettre le fonctionnement.

6.3.2 RF Exposure

This equipment complies with FCC and IC radiation exposure limits set forth for an uncontrolled environment. This equipment should be installed and operated with a minimum distance of 20 cm between the radiator and your body. This transmitter must not be co-located or operating in conjunction with any other antenna or transmitter.

Cet équipement est conforme aux limites d'exposition aux rayonnements IC établies pour un environnement non contrôlé. Cet équipement doit être installé et utilisé avec un minimum de 20 cm de distance entre la source de rayonnement et votre corps. Ce transmetteur ne doit pas être placé au même endroit ou utilisé simultanément avec un autre transmetteur ou une autre antenne.

7 Outline Dimensions

Figure 23: **Outline dimensions in millimetre**

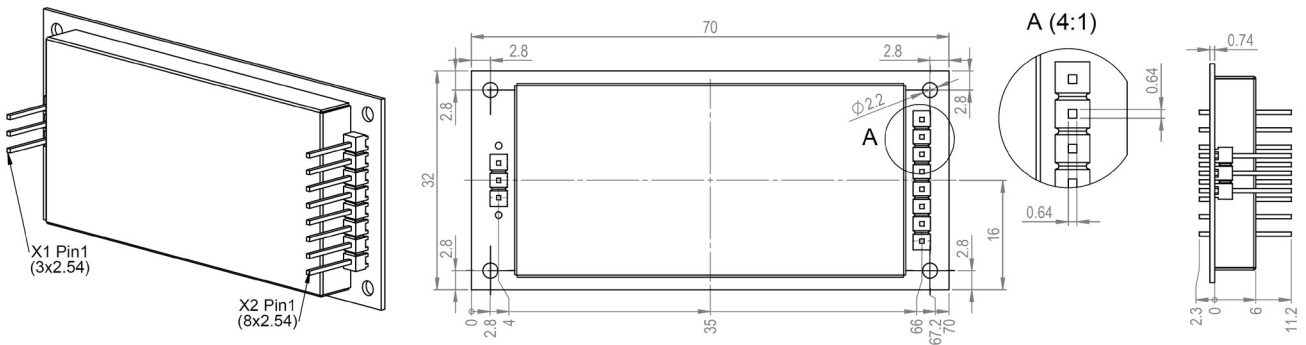

8 Order Information

The ordering number consists of different parts with the structure below.

Figure 24: **Ordering number structure**

Product	-	Customer	-	HW variant		Supply	-	SW variant
= K-MD7		= RFB for standard products		= 00 for standard variant		= H for 3.3V...5V version		= 02 for standard variant

Table 16: **Available ordering numbers**

Ordering number	Description
K-MD7-RFB-00H-02	Standard K-MD7 without PC software
K-MD7-EVAL-RFB-00H	Standard K-MD7 evaluation kit with powerful PC software

9 Revision History

- 09/2022 - Revision A: Preliminary Version
- 03/2023 - Revision B: Initial Version
- 04/2025 - Revision C: Bug Fix in communication example and signal processing workflow
- 06/2026 - Revision D: Added Information for FCC/ISED certification

RFbeam does not assume any responsibility for use of any circuitry described, no circuit patent licenses are implied and RFbeam reserves the right at any time without notice to change said circuitry and specifications.