

V-LD1

digital distance sensor

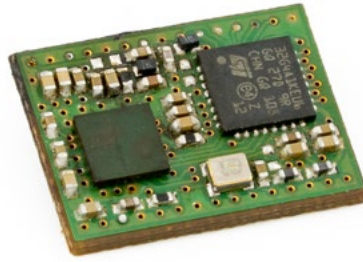

Features

- › Small and low cost digital 61GHz FMCW radar distance sensor
- › Precise distance measurement with mm accuracy
- › Can be combined with a plastic lens for higher detection distances
- › Distance measurement up to 50m (depending on medium and used lens)
- › Ultra small SMD form factor (12mm × 16mm)
- › Single 1.8V power supply for simple integration
- › Ultra low power consumption and fast start-up time
- › Distance output over serial UART interface
- › RAW data readout support (Distance spectrum, ADC values)
- › Integrated bootloader for firmware update
- › Evaluation kit available including plastic lens

Description

The V-LD1 is an easy to use 61GHz FMCW distance radar sensor with integrated signal processing. No special knowledge in analogue or digital signal processing is needed to adapt the module to different applications resulting in a fast time to market. Transmit frequency and sweep bandwidth are controlled internally and a selection of settings is available to adapt to your application requirements.

The beam width of the module itself is 170×60 degrees. However, RFbeam also offers an evaluation kit in combination with a plastic lens that focuses the beam to 8×8 degrees, which is perfect for tank level gauging applications.

Block Diagram

Figure 1: **Block diagram**

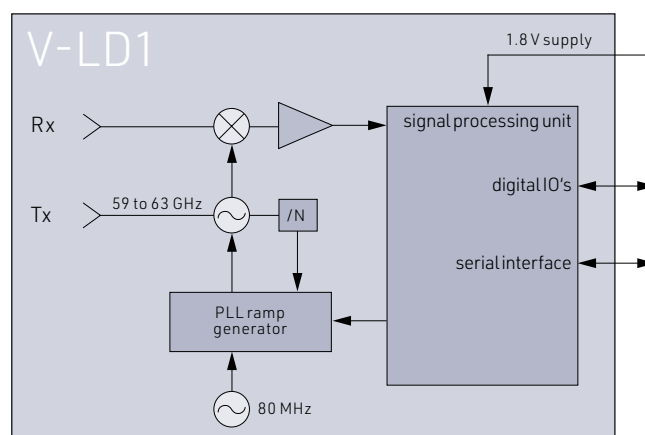

Characteristics

Parameter	Conditions / Notes	Symbol	Min	Typ	Max	Unit
Operating conditions						
Supply voltage		V_{CC}	1.71	1.8	1.89	V
Sleep current		I_{CC}		350		uA
Peak current		I_{PP}		200	250	mA
Charge per measurement	Chirp integration = 1, Low precision mode	Q_{Low}		744		uC
Charge per measurement	Chirp integration = 1, High precision mode	Q_{High}		984		uC
Operating temperature		T_{Op}	-40		+85	°C
Storage temperature		T_{St}	-40		+105	°C
RF frontend						
Transmitter frequency ¹	Range setting = 20m	f_{TX20m}	57.4		61.4	GHz
Transmitter frequency ¹	Range setting = 50m	f_{TX50m}	58.5		60.5	GHz
Output power	EIRP	P_{TX}		5		dBm
Horizontal -6dB beam width	E-Plane	W_{ϕ}		60		°
Vertical -6dB beam width	H-Plane	W_{θ}		172		°
Spurious emissions	According to ETSI 305 550	P_{Spur}		-30		dBm
Signal Processing						
Modulation				FMCW		
Range processing				1024 point FFT		
Distance range	Range setting = 20m	$r_{Dist20m}$	0.039		20.14	m
Distance range	Range setting = 50m	$r_{Dist50m}$	0.099		50.91	m
Resolution low precision mode	Range setting = 20m	Δr_{20m}		3.934		cm
Resolution low precision mode	Range setting = 50m	Δr_{50m}		9.943		cm
Resolution high precision mode	For both range settings	$\Delta r_{HighPrec}$		1		mm
Internal distance offset		r_{Offset}		-21		mm
Distance offset variation	Without a housing	Δr_{Offset}		+/-1		mm
Distance accuracy ²	In high precision mode	$r_{Accuracy}$		+/-5		mm
Detection distance	$\sigma=10\text{ m}^2$ (Water surface)	r		20		m
Detection distance with lens	$\sigma=10\text{ m}^2$ (Water surface), 8° x 8° lens	r_{lens}		50		m
Startup time		$t_{startup}$		15		ms
Processing time per frame	Chirp integration = 1, Low precision mode, Short range filter off	$t_{frameLow}$		15		ms
Processing time per frame	Chirp integration = 1, High precision mode, Short range filter off	$t_{frameHigh}$		21		ms
Additional time per chirp integration		$\Delta t_{chirpIntegration}$		3		ms
Additional time for short range filter	Added for every chirp integration	$\Delta t_{shortRangeFilter}$		5		ms
Interface						
Digital output high level voltage		$V_{OH@4mA}$	1.25		V_{CC}	V
Digital output low level voltage		$V_{OL@4mA}$	0		0.4	V
Digital input high level voltage		V_{IH}	$0.7 \times V_{CC}$		$V_{CC} + 0.3$	V
Digital input low level voltage		V_{IL}	-0.3		$0.3 \times V_{CC}$	V
Digital I/O source/sink current		I_{OH}, I_{OL}	-4		4	mA
Body						
Outline dimensions				$16 \times 12 \times 2$		mm ³
Weight				0.6		g
Connector				30-pin, SMD mountable		
ESD rating						
Electrostatic discharge	Human body model class 2	V_{ESD}			2000	V

¹ Only valid for firmware V01.08 or higher

² Starting at 15cm for 20m range and 40cm for 50m range setting. Closer measurements can have a lower accuracy

Table of contents

1	Antenna Diagram Characteristics	4
2	Pin configurations and functions	4
3	Theory of Operation	5
	3.1 Overview	5
	3.2 Signal processing	5
4	Application information	6
	4.1 Host driven operation	6
	4.2 Radar settings	6
	4.3 Detection settings	8
5	Instruction set description	9
	5.1 Hardware Layer	9
	5.2 Communication Layer	9
	5.3 Presentation Layer	10
	5.4 Application	11
	5.5 Bootloader	16
6	Integrators information	18
	6.1 Installation Instruction	18
	6.2 Europe (CE-RED)	19
	6.3 United States (FCC) and Canada (ISED)	19
7	Package information	20
	7.1 Outline Dimensions	20
	7.2 Footprint	20
	7.3 SMT Guidelines	21
	7.4 Tape and reel information	21
8	Order information	22
9	Revision history	22

1 Antenna Diagram Characteristics

This diagram shows module sensitivity in both azimuth and elevation directions. It incorporates the transmitter and receiver antenna characteristics.

Figure 2: Overall antenna diagram

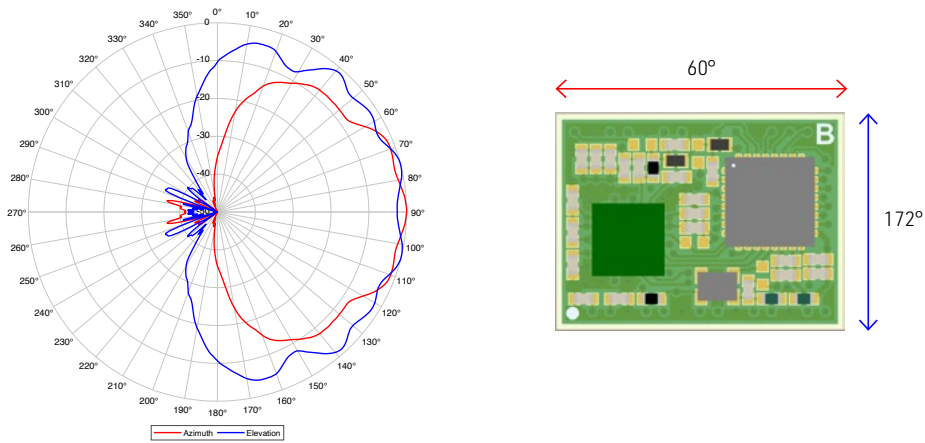

2 Pin Configurations and Functions

Figure 3: V-LD1 bottom view

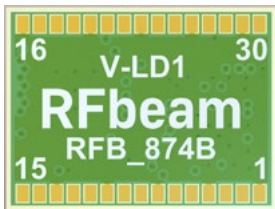

Table 1: Pin function description

Pin. No.	Name	Description
2, 3	VCC	+1.8V power supply pins
1, 4, 7, 10, 13, 16, 20, 23, 26, 29	GND	Ground pins
5, 6, 30	DNC	Do not connect
24	nRESET	Active low reset input with internal pullup. Can be left floating
15	MODE0	Reserved for future use, do not connect
17	MODE1	Reserved for future use, do not connect
11	UART_RX	Serial interface receive pin
12	UART_TX	Serial interface transmit pin
21	I2C_SCL/GPIO	Reserved for future use, do not connect
22	I2C_SDA/GPIO	Reserved for future use, do not connect
18	ADDR0/GPIO	Reserved for future use, do not connect
19	ADDR1/GPIO	Reserved for future use, do not connect
8	CAN_TX/GPIO	Reserved for future use, do not connect
9	CAN_RX/GPIO	Reserved for future use, do not connect
27	DIG_OUT0/GPIO	Reserved for future use, do not connect
28	DIG_OUT1/GPIO	Reserved for future use, do not connect
14	DAC_OUT/GPIO	Reserved for future use, do not connect
25	ADC_IN/GPIO	Reserved for future use, do not connect

3 Theory of operation

3.1 Overview

The V-LD1 is a digital FMCW distance measurement sensor and consists of an analogue RF frontend and a powerful signal processor with a fully digital serial interface. The RF frontend features a PLL controlled transmitter with a FMCW modulation mode and one receiver. The signal processing unit controls the FMCW modulation and samples the ADC values for further processing.

A range FFT is then calculated to measure the distance to all targets inside of the antenna beam. The sensor can separate targets based on the distance resolution of the used distance setting. Further the signal processing is capable to compute a high accuracy distance of one target if this option is enabled.

 The distance zero point is at the top of the RF frontend

3.2 Signal processing

The signal processing of the V-LD1 uses different processing stages to measure the distance to static objects by means of a FMCW modulation. To get the full control in an application it is possible to read out the data of each processing step over the serial interface.

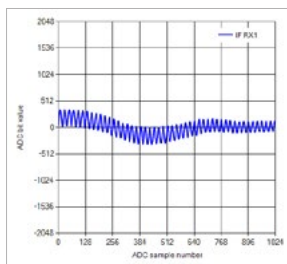

Raw ADC data (RADC)

- › Controls the FMCW sweeps
- › Samples ADC data of the RF frontend

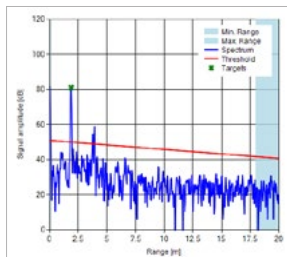

Raw FFT data (RFFT)

- › Calculates a range FFT based on the ADC data
- › Implements the long integration mode
- › Adds the threshold line to the RFFT data
- › Can be filtered in distance

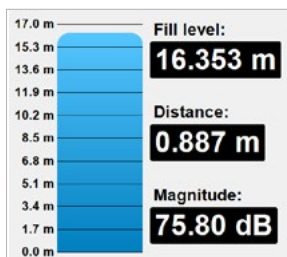

Raw target data (PDAT)

- › Search all targets above a threshold in the FFT
- › Calculates the distance to the first, strongest or last target
- › Estimates the high precision distance with mm accuracy

4 Application Information

4.1 Host driven operation

The V-LD1 needs only a connection to a power supply and a serial interface of a host (for example MCU or PC) to read out the distance measurement data and configure the sensor if needed. Further it is also possible to read out advanced processing data like the ADC or FFT values or to start a firmware update over the integrated bootloader.

Figure 4: **MCU or PC connection example**

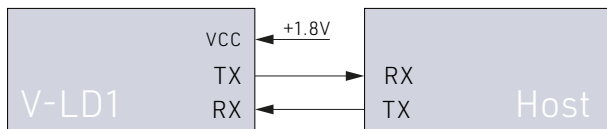

As soon as the power supply is switched on, the sensor starts up into a SLEEP mode with very low power consumption. The sensor remain in this mode until the host sends a request to switch to the RUN mode. See chapter Data output on page 12 for a communication example.

The sensor does not measure continuously what allows the host to define the update rate and average power consumption depending on the requirements for the application.

4.2 Radar settings

The V-LD1 features different parameters to adjust the functionality of the sensor to the needs of different applications. All parameters are stored in the radar parameter structure which can be read and write over the serial interface. The structure and serial protocol are described in the chapter Instruction Set Description on page 10.

4.2.1 Distance range

The distance range parameter defines the maximum unambiguous distance measurement range of the sensor. As long as the high precision mode is enabled the sensor will have the same high precision distance resolution independent of the distance range setting. If it is disabled the distance resolution depends on the distance range setting.

Table 2: **Distance range settings**

Max. distance	Resolution low precision	Resolution high precision
20m	3.934cm	1mm
50m	9.943cm	1mm

4.2.2 TX power

It is possible to reduce the output power of the sensor via a parameter. Reducing the output power may be useful when the sensor is used in short range applications or in combination with a focusing plastic lens (as presented in the V-LD1 evaluation kit) to comply with regulations for different countries and end applications.

4.2.3 Chirp integration count

The sensor features a chirp integration mode to reduce the FFT noise floor which results in a higher SNR. The integration is controllable by a parameter in the range of 1 to 100.

By default, a chirp integration of 1 is used, which means that one FMCW sweep is performed per measurement. If the parameter is set to 10, the sensor integrates 10 FMCW sweeps per measurement, which lowers the noise floor in the FFT with the disadvantage that each measurement takes longer and consumes more power.

Figure 5: **Default integration mode vs. integration mode 10**

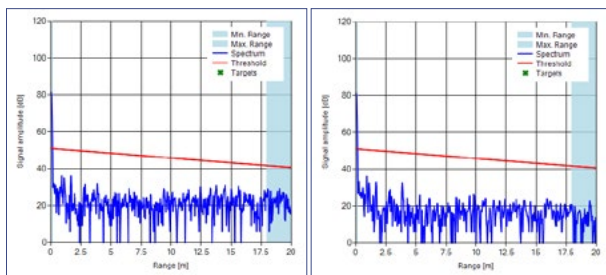

4.2.4 Short range filter

There is a high peak in the FFT data based on direct signal leakage between the TX and RX antenna in the RF frontend. This leakage is clearly visible in the FFT from bin 0 to 4.

Per default the leakage is filtered out by the minimum distance filter which is set to bin 5 to filter it out by distance with the drawback that it is not possible to measure objects at short distances.

The sensor features a short range filter what can be enabled to filter out the direct leakage in the short range. This feature can be used to enable short range distance measurements of strong reflectors.

The filter is deactivated by default and can be activated via a parameter. When activated, it makes sense to reduce the minimum detection distance and the threshold offset to achieve the best results.

When the filter is activated, an additional processing time of approx. 5ms per measurement is added. In combination with the chirp integration function, the additional time is added for each additionally set chirp, which is why it is recommended to activate the filter only when it is really needed.

⚠ To measure targets in the short range it is necessary that the reflected signal of the target is stronger than the direct leakage. This is true for water based liquids in combination with a plastic lens.

Figure 6: **Short range distance filter disabled vs. enabled**

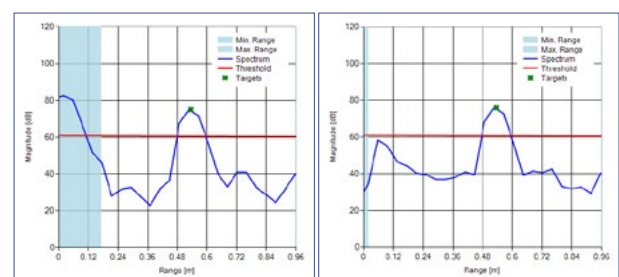

4.3 Detection settings

4.3.1 Target filter

The sensor can measure the distance to one target. The target filter is a parameter that allows the user to select which target to use for distance measurement.

 The target filter only considers targets that are not filtered out by the distance filter.

Table 3: Different target filters

Setting	Description
Strongest first	Measure the distance of the target with the highest magnitude above the threshold
Nearest first	Measure the distance to the first target above the threshold
Farthest first	Measure the distance of the last target above the threshold

4.3.2 Precision

By default, the sensor operates in a high precision mode. This means that after determining the distance via the FFT, an additional measurement is performed to obtain a more accurate distance in the mm range.

The high precision mode can be switched off, which shortens the calculation time, resulting in a lower power consumption per measurement.

4.3.3 Threshold offset

The threshold offset is adjustable and defines the distance in dB between the 0 dB floor of the raw FFT data and the threshold line. The processing in the V-LD1 searches only for targets that are above this threshold line. The smaller the offset the more sensitive the sensor will be. A higher offset will reduce the sensitivity.

Figure 7: Low vs. high threshold offset

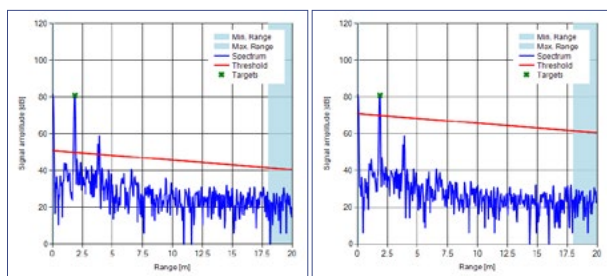

4.3.4 Distance filter

It is possible to limit the distance range in which the processing searches for targets via the distance filter in spectrum points (bins) of the FFT. The user can set a minimum and maximum filter, which allows filtering out unwanted targets in areas that are not of interest.

The real filtered distance depends on the used range setting and the distance offset of the sensor. It can be calculated with the following formula:

$$Distance = bin * \Delta r + r_{offset}$$

$$bin = Filter\ setting\ [1..511]$$

$$\Delta r = Range\ resolution$$

$$r_{offset} = Internal\ distance\ offset$$

For example, the default minimum distance is calculated as follows:

$$bin = 5$$

$$\Delta r = 3.934cm\ @\ 20m\ range$$

$$r_{offset} = -21mm$$

$$Filter_{min} = 5 * 3.934cm - 21mm = 17.6cm$$

Figure 8: No distance filter vs. enabled distance filter

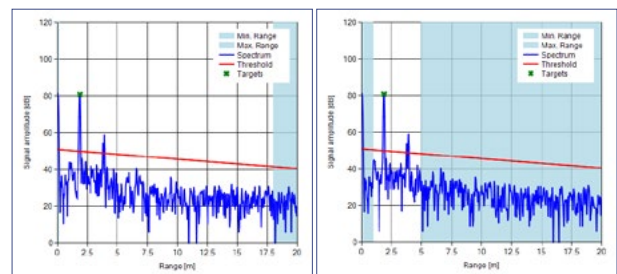

4.3.5 Distance average

For a smooth output of an accurate distance measurement, it could be useful to take an average between multiple measurements. The sensor already implements a distance average feature which is set to 5 per default to smooth the output.

The user can change the distance average parameter from 1 to a maximum of 255 measurements.

5 Instruction Set Description

5.1 Hardware Layer

The hardware layer is based on a simple UART connection with a configurable baud rate. The sensor always starts up with its default baud rate. The default baud rate can be changed over the INIT command as described in the chapter Connection on page 11.

Table 4: **Default serial connection settings**

Parameter	Configuration
Baud rate	115200
Data bits	8
Parity	Even
Stop bits	1
Flow control	None

5.2 Communication Layer

5.2.1 Client-Server

Figure 9: **Client-Server model**

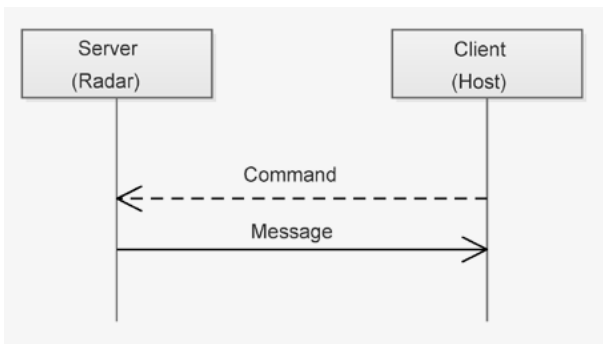

The communication is based on a client-server model. There are two types of packets transmitted. Commands are sent from client to server and messages are sent from server to client.

5.2.2 Handshaking

Figure 10: **Handshaking**

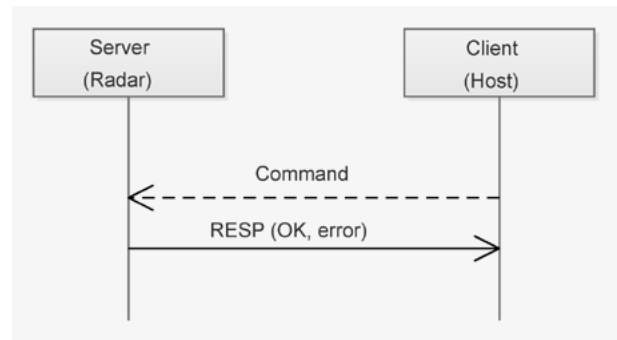

Every command sent by the client is acknowledged by the server with a response message (RESP). The response message includes an error code what delivers information data about the success or failure of the received command.

5.2.3 Connection

Figure 11: Connection

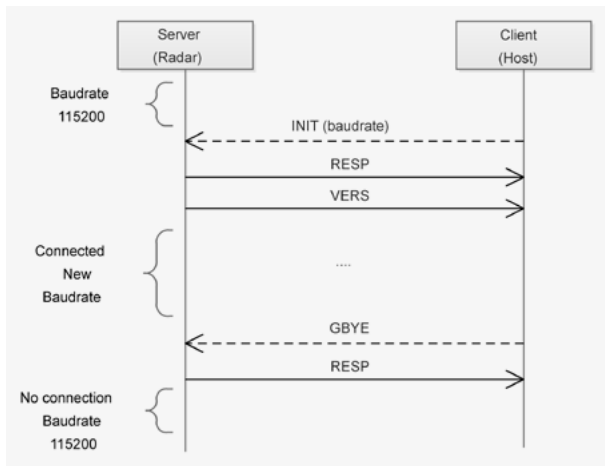

The server starts up with a default baud rate of 115200 baud. The client has to establish a connection with the INIT command where it needs to define the baud rate to be used for the communication. After acknowledging of the INIT command by a RESP message a VERS message with a firmware string follows before the server changes the baud rate to the selected one from the INIT command.

The firmware string of the VERS message can be used to check if the sensor has started into the application or to the bootloader. The sensor only starts into the bootloader if a jump bootloader command was sent from the application or if there is a corrupt firmware programmed.

To disconnect, the GBYE command has to be sent by the client. After acknowledging the GBYE message the server changes back to his default baud rate.

5.3 Presentation Layer

All commands and messages sent have the format described in table below.

Table 5: Packet format

Description	Datatype	Length
Header The header describes the command or message type (e.g. INIT, RADC, ...)	ASCII character	4 Bytes
Payload Length Defines the size of the added payload. The payload length is always sent even if the payload is zero. It is sent as little endian (LSB first).	UINT32	4 Bytes
Payload The payload is message and command dependent. If the payload includes datatypes with multiple bytes (e.g. UINT16, INT32, ...) then they are sent as little endian (LSB first).	Binary data	x

5.4 Application

5.4.1 Data output

The client can request application messages from the server in a handshake mode. The client must request each message with the GNFD command.

The sensor goes into a sleep mode between requests as long as the client reads the messages at the default baud rate of 115200. RFbeam recommends using this mode for the most power efficient operation.

Higher baud rates are only recommended if the client wants to read data intensive messages like RADC or RFFT in combination with fast readout requests.

Figure 12: Read messages with baud rate = 115200

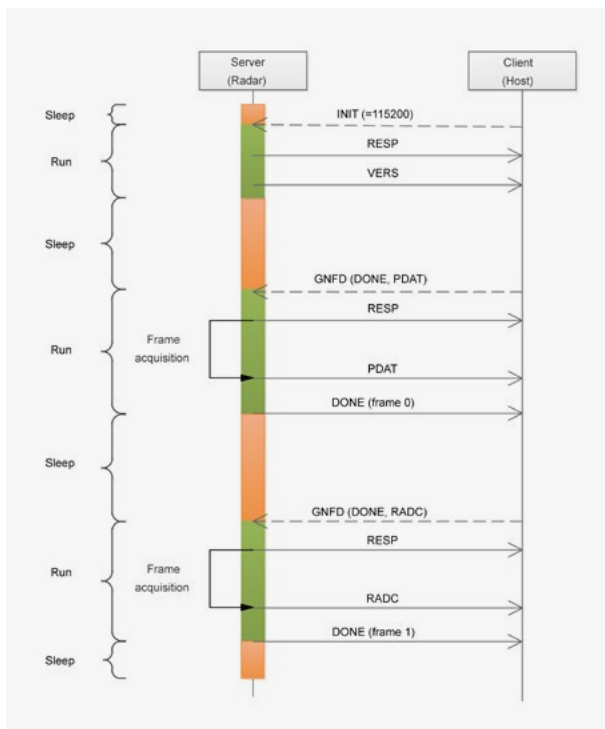
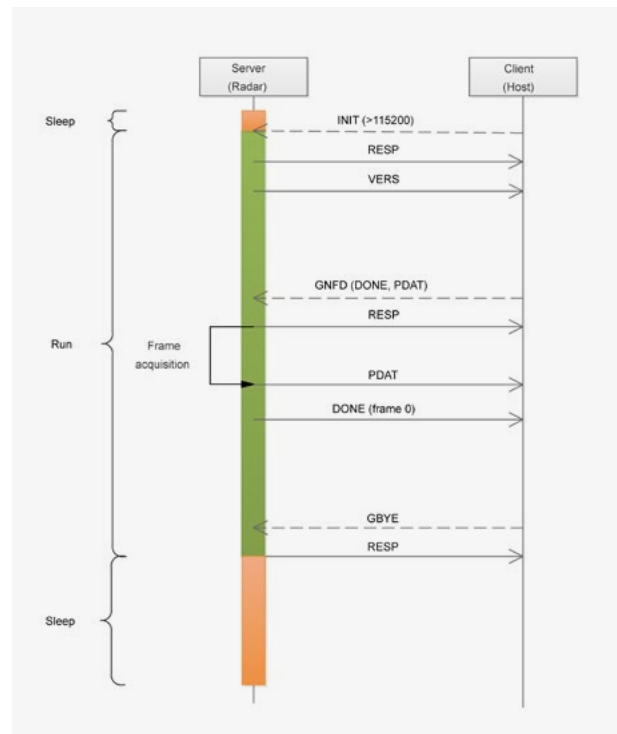

Figure 13: Read messages with baud rate > 115200



5.4.2 Get and set parameter structure

The client can set every parameter with a single command. But there is also the possibility to set all parameters together within a parameter structure or read out this structure. The structure is defined in detail in the next chapter.

Figure 14: **Get parameter structure**

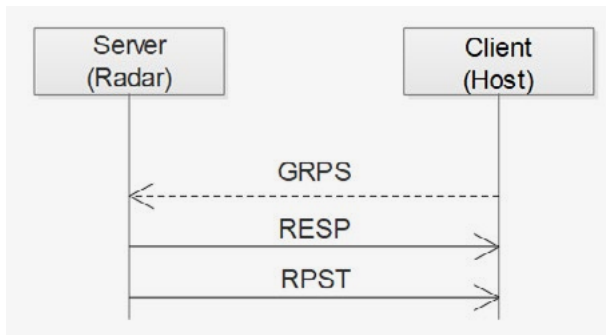
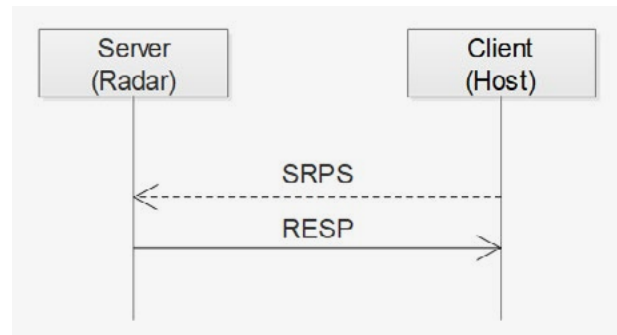

Figure 15: **Set parameter structure**



5.4.3 Parameter structure

The radar has a set of parameters which are stored in a structure. The structure can be read out by the GRPS command and set by the SRPS command. Further it is possible to change each parameter by a dedicated command.

Table 6: **Radar parameter structure**

Description	Datatype	Payload length	Payload data	Default settings
Firmware version	STRING	19	Zero-terminated String	V-LD1_APP-RFB-YYYY
Unique ID	STRING	12	Zero-terminated String	L1234n12345
✎ Unique ID is factory programmed				
Distance range	UINT8	1	0 = 20m 1 = 50m	0 = 20m
Threshold offset [dB]	UINT8	1	Minimum = 20dB Maximum = 90dB	40dB
Minimum range filter [bin]	UINT16	2	Minimum = 1 Maximum = 510	5 -> app. 0.18m
Maximum range filter [bin]	UINT16	2	Minimum = 2 Maximum = 511	460 -> app. 18.1m
Distance average count	UINT8	1	Minimum = 1 Maximum = 255	5
Target filter	UINT8	1	0 = Strongest first 1 = Nearest first 2 = Farthest first	1 = Nearest first
Distance precision	UINT8	1	0 = Low precision 1 = High precision	1 = High precision
TX power	UINT8	1	0 = Minimum output power 31 = Maximum output power	31 = Maximum output power
Chirp integration count	UINT8	1	Minimum = 1 Maximum = 100	1
Short range distance filter	UINT8	1	0 = Filter disabled 1 = Filter enabled	0 = Filter disabled

5.4.4 Commands

The following table provides detailed information about all possible commands of the application:

Table 11: **Application commands**

Header	Payload length	Description	Datatype	Payload data																
INIT	1	Command to start a connection with a defined baud rate.	UINT8	Baud rate in bit/s: 0=115200 1=460800 2=921600 3=2000000																
GNFD	1	Get next frame data request to read out application messages once.  Enable DONE message to read out frame number.	UINT8	Binary coded bit-field for messages: 0=disabled, 1=enabled Bit-field representation: <table border="1" style="margin-left: 20px;"> <tr> <td>7</td> <td>6</td> <td>5</td> <td>4</td> <td>3</td> <td>2</td> <td>1</td> <td>0</td> </tr> <tr> <td>X</td> <td>X</td> <td>DONE</td> <td>X</td> <td>X</td> <td>PDAT</td> <td>RFFT</td> <td>RADC</td> </tr> </table> X = don't care	7	6	5	4	3	2	1	0	X	X	DONE	X	X	PDAT	RFFT	RADC
7	6	5	4	3	2	1	0													
X	X	DONE	X	X	PDAT	RFFT	RADC													
GRPS	0	Read complete radar parameter structure	-	-																
SRPS	43	Write complete radar parameter structure	STRUCT	See chapter «Parameter structure» for detailed information about the format of the data structure.  Unique ID is factory programmed and won't be overwritten by SRPS command																
RFSE	0	Restore factory settings	-	-																
GBYE	0	Disconnect from sensor	-	-																
RRAI	1	Distance range	UINT8	0 = 20m 1 = 50m																
THOF	1	Threshold offset [dB]	UINT8	Minimum = 20dB Maximum = 90dB																
MIRA	2	Minimum range filter [bin]	UINT16	Minimum = 1 Maximum = 510																
MARA	2	Maximum range filter [bin]	UINT16	Minimum = 2 Maximum = 511																
RAVG	1	Distance average count	UINT8	Minimum = 1 Maximum = 255																
TGFI	1	Target filter	UINT8	0 = Strongest first 1 = Nearest first 2 = Farthest first																
PREC	1	Distance precision mode High precision mode enables the mm accuracy feature of the sensor.	UINT8	0 = Low precision 1 = High precision																
TXPW	1	TX power	UINT8	0 = Minimum output power 31 = Maximum output power																
INTN	1	Chirp integration count	UINT8	Minimum = 1 Maximum = 100																
SRDF	1	Short range distance filter	UINT8	0 = Short range filter disabled 1 = Short range filter enabled																
JBTL	0	Jump to bootloader	-	-																

5.4.5 Messages

The following table provides detailed information about all possible messages of the application:

Table 8: **Application messages**

Header	Payload length	Description	Datatype	Payload data									
RESP	1	Response message including an error code	UINT8	Error codes: 0=OK, no error 1=Unknown command, 2=Invalid parameter value 3=Invalid RPST version 4=Uart error (parity, framing, noise) 5=No calibration values 6=Timeout 7= Application corrupt or not programmed									
VERS	19	Application version	STRING	Version string including Null-terminator: V-LD1_APP-RFB-YYXX YY=Variant, XX=Revision									
RADC	2048	Raw ADC values <div style="border: 1px solid black; padding: 2px; width: fit-content; margin-top: 5px;">⚠ It is recommended to use the highest baud rate when reading out RADC messages</div>	INT16	1024 ADC values									
RFFT	2048	Raw FFT <div style="border: 1px solid black; padding: 2px; width: fit-content; margin-top: 5px;">⚠ It is recommended to use the highest baud rate when reading out RFFT messages</div>	STRUCT	<table border="1" style="width: 100%; border-collapse: collapse;"> <thead> <tr> <th>Description</th> <th>Datatype</th> <th>Length</th> </tr> </thead> <tbody> <tr> <td>512 spectrum points [dB x 100]</td> <td>UINT16</td> <td>1024</td> </tr> <tr> <td>512 threshold points [dB x 100]</td> <td>UINT16</td> <td>1024</td> </tr> </tbody> </table>	Description	Datatype	Length	512 spectrum points [dB x 100]	UINT16	1024	512 threshold points [dB x 100]	UINT16	1024
Description	Datatype	Length											
512 spectrum points [dB x 100]	UINT16	1024											
512 threshold points [dB x 100]	UINT16	1024											
PDAT	0-6	The detected target. If no target is detected there is no payload.	STRUCT	<table border="1" style="width: 100%; border-collapse: collapse;"> <thead> <tr> <th>Description</th> <th>Datatype</th> <th>Length</th> </tr> </thead> <tbody> <tr> <td>Distance [m]</td> <td>FLOAT</td> <td>4</td> </tr> <tr> <td>Magnitude of target [dB x 100]</td> <td>UINT16</td> <td>2</td> </tr> </tbody> </table>	Description	Datatype	Length	Distance [m]	FLOAT	4	Magnitude of target [dB x 100]	UINT16	2
Description	Datatype	Length											
Distance [m]	FLOAT	4											
Magnitude of target [dB x 100]	UINT16	2											
DONE	4	Frame done information with frame number	UINT32	Frame number since reset.									
RPST	43	Radar parameter structure	STRUCT	See chapter «Parameter structure» for details									

5.4.6 Communication example

Figure 16: **Example INIT command with 115200 baud**

host to radar	Header: INIT				Length: 1 Byte				Payload 1 Byte: value 0 = 115200 baud	
	0x49	0x4E	0x49	0x54	0x01	0x00	0x00	0x00	0x00	
radar to host	Header: RESP				Length: 1 Byte				Payload 1 Byte: value 0 = OK	
	0x52	0x45	0x53	0x50	0x01	0x00	0x00	0x00	0x00	
radar to host	Header: VERS				Length: 19 Byte				Payload 19 Byte: Firmware string	
	0x56	0x45	0x52	0x53	0x13	0x00	0x00	0x00	For example: V-LD1_APP-RFB-0100 if connected to application or V-LD1_BTL-RFB-0100 for bootloader	

Figure 17: **Example read out distance with GNFD**

host to radar	Header: GNFD				Length: 1 Byte				Payload 1 Byte: value 4 = only PDAT enabled				
	0x47	0x4E	0x46	0x44	0x01	0x00	0x00	0x00	0x04				
radar to host	Header: RESP				Length: 1 Byte				Payload 1 Byte: value 0 = OK				
	0x52	0x45	0x53	0x50	0x01	0x00	0x00	0x00	0x00				
radar to host	Header: PDAT				Length: 6 Byte				Payload 6 Byte: PDAT target detected				
	0x50	0x44	0x41	0x54	0x06	0x00	0x00	0x00	0x9B	0xC5	0x39	0x40	0xB0

Figure 18: **Example GBYE message**

host to radar	Header: GBYE				Length: 0 Byte					
	0x47	0x42	0x59	0x45	0x00	0x00	0x00	0x00		
radar to host	Header: RESP				Length: 1 Byte				Payload 1Byte: value 0 = OK	
	0x52	0x45	0x53	0x50	0x01	0x00	0x00	0x00	0x00	

Table 9: **Example PDAT structure conversion**

Description	PDAT payload LSB first				Value	Datatype	Conversion	Result
Distance [m]	0x9B	0xC5	0x39	0x40	0x4039C59B	Float	-	2.903 m
Magnitude of target [dBx100]	0xB0	0x1D	-	-	0x1DB0	UINT16	/100	76.00 dB

5.5 Bootloader

The bootloader can be invoked by sending a «Jump to bootloader» command from the application. After receiving the bootloader jump command, the sensor restarts, stays in the bootloader and waits for a new connection via an INIT command.

The host receives a VERS message back after a successful INIT command, which can be used to check if the sensor has started into the bootloader.

Figure 19: Jump to bootloader out of the application

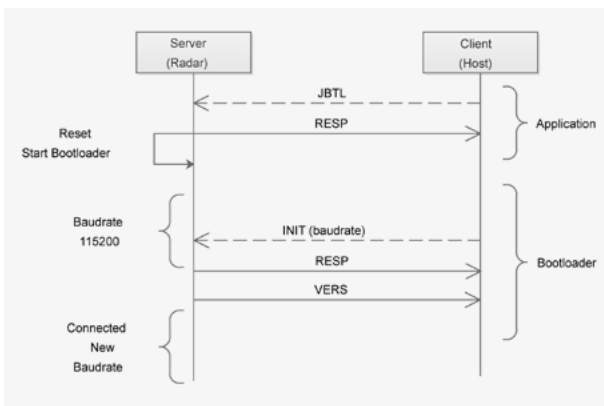

In the next step, the host must send the complete firmware binary (provided by RFbeam Microwave) in packets of maximum 2048 bytes to the radar sensor using the WMEM command.

After successfully writing the binary file, a GBYE command must be sent to complete the update. The corresponding RESP message returns feedback with the error code whether the update was successful or not.

The sensor then restarts and the host can establish a new connection with an INIT command. The VERS message sent during this process provides information about the new firmware version.

Figure 20: Successful firmware update sequence

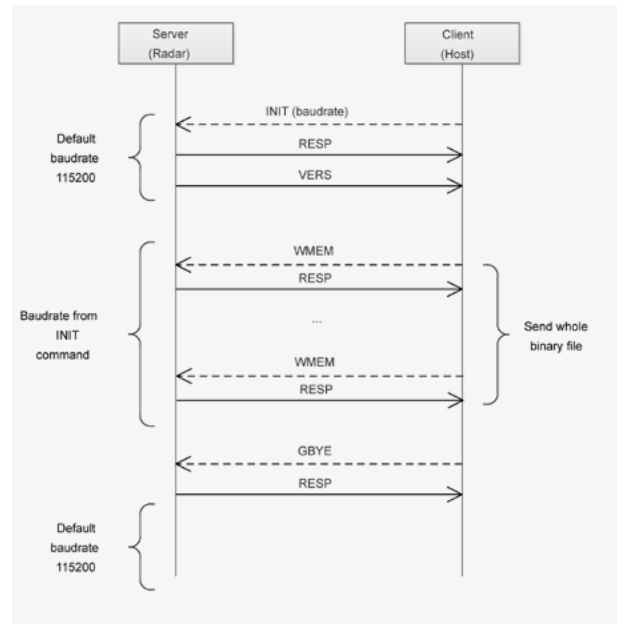

5.5.1 Commands

The following table provides detailed information about all possible commands of the bootloader:

Table 10: **Bootloader commands**

Header	Payload length	Description	Datatype	Payload data												
INIT	1	Command to start a connection with a defined baud rate.	UINT8	Baud rate in bit/s: 0=115200 1=460800 2=921600 3=2000000												
GBYE	0	Disconnect	-	-												
WMEM	9 to 2056	Write a flash memory page to a defined memory address.	STRUCT	Each page write command needs the following data structure: <table border="1" data-bbox="901 689 1442 1003"> <thead> <tr> <th>Byte</th> <th>Length</th> <th>Description</th> </tr> </thead> <tbody> <tr> <td>0-3</td> <td>4</td> <td>Relative memory address in little endian (LSB first). Starts at 0x000000 and must be a multiple of 0x800 with a maximum of 0x06E000.</td> </tr> <tr> <td>4-7</td> <td>4</td> <td>Data length of the binary data. The length needs to be between 1 and 2048.</td> </tr> <tr> <td>8-2055</td> <td>1 to 2048</td> <td>Binary application data</td> </tr> </tbody> </table>	Byte	Length	Description	0-3	4	Relative memory address in little endian (LSB first). Starts at 0x000000 and must be a multiple of 0x800 with a maximum of 0x06E000.	4-7	4	Data length of the binary data. The length needs to be between 1 and 2048.	8-2055	1 to 2048	Binary application data
Byte	Length	Description														
0-3	4	Relative memory address in little endian (LSB first). Starts at 0x000000 and must be a multiple of 0x800 with a maximum of 0x06E000.														
4-7	4	Data length of the binary data. The length needs to be between 1 and 2048.														
8-2055	1 to 2048	Binary application data														

 Use only firmware update files provided by RFbeam Microwave.

5.5.2 Messages

The following table provides detailed information about all possible messages of the bootloader:

Table 11: **Bootloader messages**

Header	Payload length	Description	Datatype	Payload data
RESP	1	Response message including an error code.	UINT8	Error codes: 0=OK, no error 1=Unknown command, 2=Invalid parameter value 3=Invalid RPST version 4=Uart error (parity, framing, noise) 5=No calibration values 6=Timeout 7=Application corrupt or not programmed
VERS	19	Bootloader version	STRING	Version string including Null-terminator: V-LD1_BTL-RFB-YYXX YY=Variant, XX=Revision

6 Integrators information

6.1 Installation Instruction

6.1.1 Distance offset

The distance offset to the zero plane of the sensor changes depending on the radar coverage used due to a different propagation speed of the electromagnetic waves in the radar coverage itself compared to air. The change in distance offset depends on the thickness and material used. RFbeam therefore recommends determining the distance offset in the final application together with the housing.

6.1.2 Mechanical enclosure

It is possible to hide the sensor behind a so called radome (short for radar dome) to protect it from environmental influences or to simply integrate it in the case of the end product. A radar sensor can see through different types of plastic and glass of any colour as long as it is not metallized. This allows for a very flexible design of the housing as long as the rules below are observed.

- › Cover must not be metallic.
- › No plastic coating with colours containing metallic or carbon particles.
- › Distance between cover and front of Radar sensor should be $\geq 2.4\text{mm}$
- › Cover thickness is very important and depends on the used material. Examples can be found in the application note «AN-03-Radome».
- › Vibrations of the Radar antenna relatively to the cover should be avoided, because this generates signals that can trigger the output
- › The cover material can act as a lens and focus or disperse the transmitted waves. Use a constant material thickness within the area used for transmission to minimize the effect of the radome on the radiated antenna pattern.



Detailed information about the calculation and thickness for different cover materials can be found in the application note «AN-03-Radome».

6.1.3 Plastic lens

The V-LD1 can be used in combination with a plastic lens to focus the beam width. With a focused beam, the measuring area can be limited and the detection distance increased, which can be useful in level sensing applications.

RFbeam supplies the V-LD1-EVAL Evaluation Kit with a standard plastic lens which focuses the beam width to approximately 8×8 degrees.

It is possible to integrate such a plastic lens directly into the housing of the sensor and use it as radome. RFbeam can help you with the integration of such a lens.

6.2 Europe (CE-RED)

The V-LD1 module is a Radio Equipment Directive (RED) assessed radio module that is CE-compliant. It has been manufactured and tested with the intention of being integrated into a final product.

Under the RED, any final product incorporating a radio module is classified as a radio product and falls within the scope of the directive. OEM and host manufacturers are ultimately responsible for ensuring the compliance of the final product, including the module. Before the product can be placed on the EU market, it must be reassessed against all essential requirements of the RED, specifically:

- Article 3.1: Health and safety, electromagnetic compatibility
- Article 3.2: Efficient use of the radio spectrum
- Article 3.3: Specific requirements
- Article 3.4: Common charger requirements

The RED provides various conformity assessment procedures to demonstrate compliance (see RED Guide, Chapter 2.6b). When a radio module demonstrates compliance with Articles 3.2 and 3.3 using harmonized standards listed in the Official Journal of the EU (OJEU), an EU type examination by a notified body is not required. In such cases, conformity can be declared using Module A (Annex II of the RED), which allows internal production control.

However, the V-LD1 complies with Article 3.2 using EN 305 550, which is not yet a harmonized standard. As a result, an EU type examination is mandatory to demonstrate conformity.

RFbeam has conducted an EU type examination for the V-LD1, both standalone and in combination with the default plastic lens of the evaluation kit. OEM integrators can reuse RFbeam's EU type examination when integrating the V-LD1 into their end product. Test reports for the V-LD1, with and without the lens, are available upon request.

6.2.1 RF Exposure Information (MPE)

This device has been tested and meets applicable limits for RF exposure. Detailed calculations demonstrating compliance with RED Article 3.1(a) are available upon request.

6.2.2 Simplified Declaration of Conformity (DoC)

RFbeam Microwave GmbH hereby declares that the radio equipment type V-LD1 complies with Directive 2014/53/EU. The full Declaration of Conformity is available at www.rfbeam.ch.

6.3 United States (FCC) and Canada (ISED)

Single modular approval for 61 GHz devices is no longer possible in North America. RFbeam has designed the V-LD1 to facilitate FCC/ISED certification for both indoor and outdoor use. OEM integrators are responsible for ensuring the compliance, testing, and certification of their end products.

7 Package Information

7.1 Outline Dimensions

Figure 21: **Outline dimensions in mm**

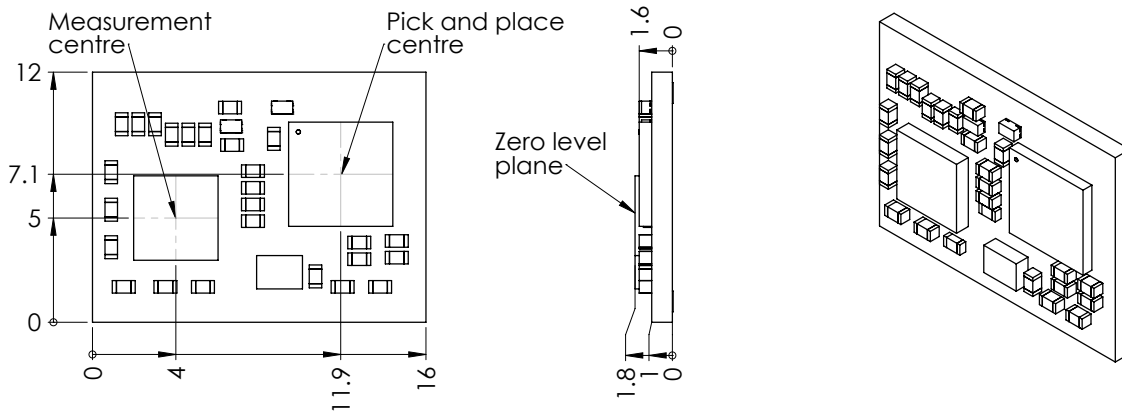

7.2 Footprint

RFbeam recommends to use the same size for the cooper pad and stencil opening of 0.7 x 1.0 mm with a solder mask opening which is 75um bigger than the pad itself.

Figure 22: **Recommended footprint in mm top view**

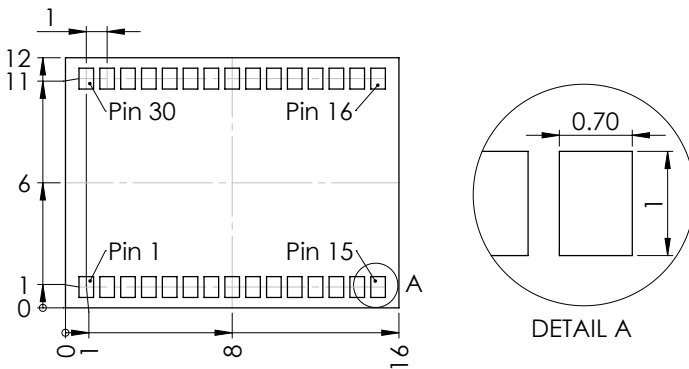

7.3 SMT Guidelines

For all soldering processes, the optimal reflow profile for a PCB assembly depends on several factors, which depend not only on the RFbeam sensor, but also on the selected solder paste and the size and layout of all other components as well as the PCB layer structure.

 Repeated reflow soldering processes are not recommended. To avoid falling off, the modules should be soldered in the last reflow process step.

Figure 23: Typical reflow profile



7.4 Tape and reel information

Figure 24: Orientation and tape and reel drawing in mm

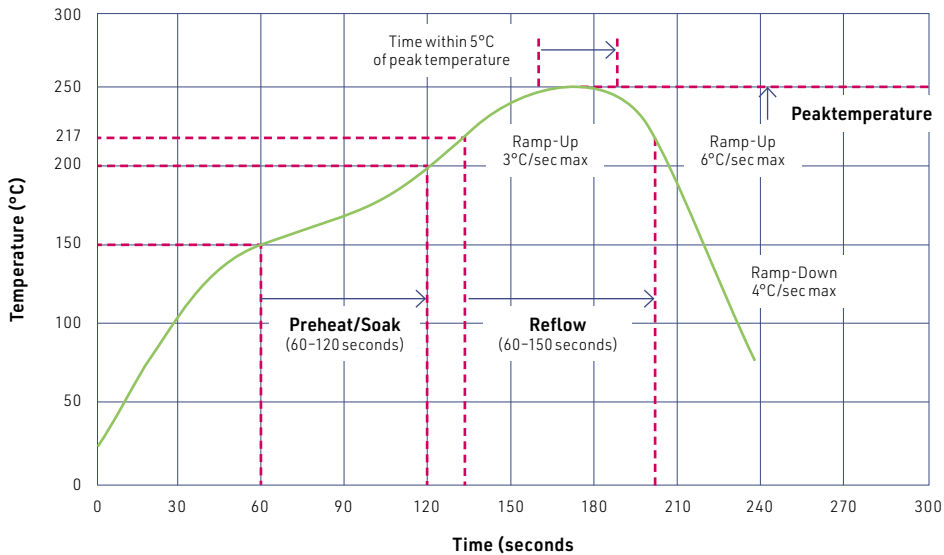
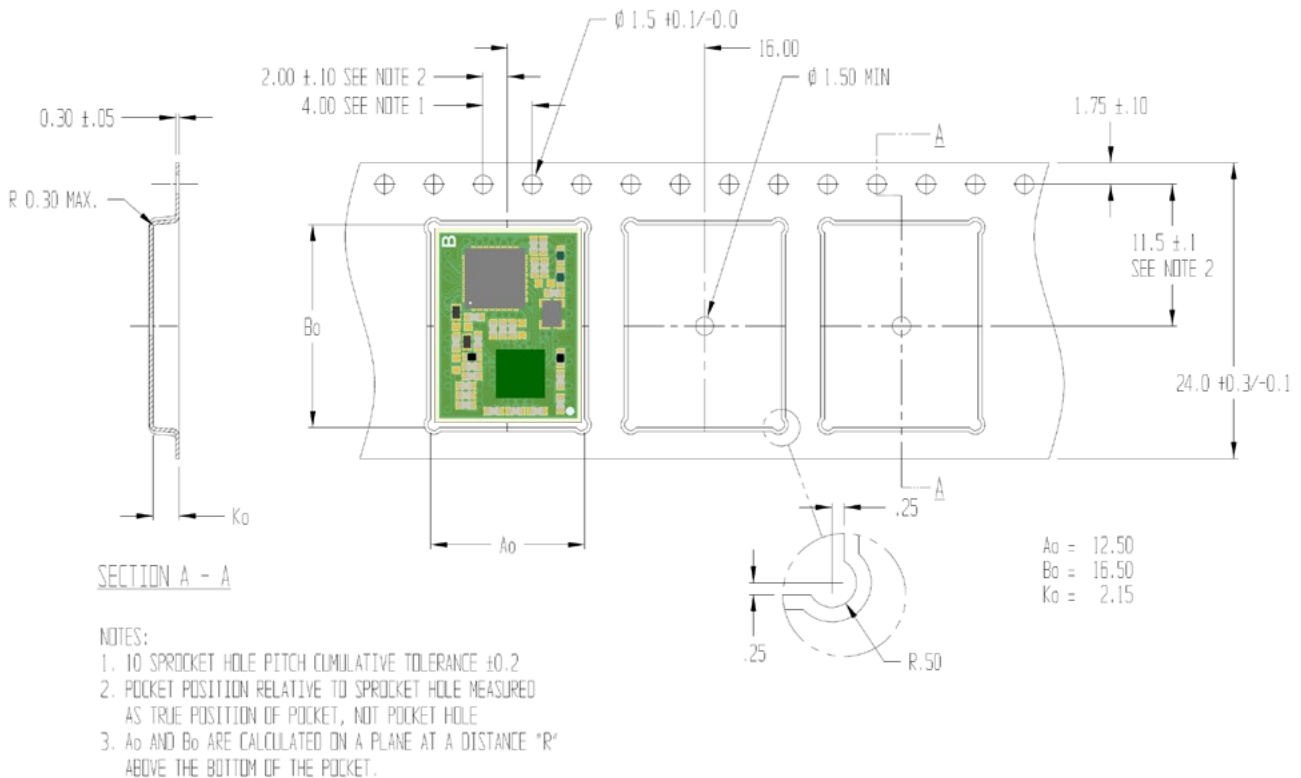

8 Order Information

The ordering number consists of different parts with the structure below.

Figure 25: **Ordering number structure**

Product	-	Customer	-	HW variant		Supply	-	SW variant
= V-LD1		= RFB for standard products		= 00 for standard variant		= M for 1.8 V version		= 01 for standard variant

Table 12: **Available ordering numbers**

Ordering number	Description
V-LD1-RFB-00M-01	Standard V-LD1 sensor module
V-LD1-EVAL-RFB-00H	Standard V-LD1 evaluation kit with powerful PC software and plastic lens

9 Revision History

- 02/2023 - Revision A:
 - Preliminary version
- 05/2023 - Revision B:
 - Added internal distance offset
 - Added short range filter functionality
 - Changed unit of distance filters to bin instead of mm
- 07/2023 - Revision C:
 - Changed typical startup time to 15ms
- 11/2024 - Revision D:
 - Changed transmitter frequency for better CE/FCC compatibility
 - Added integrators information for CE and FCC

RFbeam does not assume any responsibility for use of any circuitry described, no circuit patent licenses are implied and RFbeam reserves the right at any time without notice to change said circuitry and specifications.