

V-LD1-EVAL

V-LD1 evaluation kit

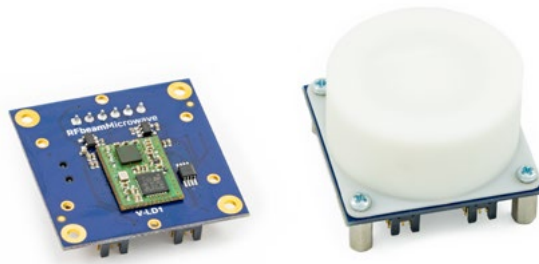

Features

- › Easy evaluation of the digital radar sensor V-LD1
- › Detachable plastic lens included
- › Powerful control panel GUI included
- › Real-time streaming and visualisation of all sensor data
- › Data recording and playback including video support using a webcam
- › Simple firmware update
- › Saves time to market and reduces NRE costs

Applications

- › Getting started with the V-LD1
- › Evaluate the sensor in combination with a dielectric lens
- › Real-time optimisation of the radar parameters for different applications
- › Situation recording including video data for later analysis in the lab

Description

The V-LD1 evaluation kit is a powerful tool to evaluate the use of the V-LD1 for your application idea. The kit consists of a PCB with a mounted V-LD1 sensor in the centre. A detachable plastic lens is mounted on top of the sensor for focussing the radar beam to app. 8° to 8° for longer detection distances which is ideal for tank level gauging applications. Further it features an easy connection to a PC over a simple USB connection without the need of an external power supply.

With the supplied powerful Control Panel software, the development time is reduced drastically. All the sensor parameters can be modified using the Control Panel. The influence of changed parameters can be directly checked in the real-time views of the software. The control panel features a lot of different views to analyse the measured data in detail. Furthermore it is possible to record all measured data and replay it directly in the software to analyse different application scenarios offline without the sensor.

Control Panel

Figure 1: **Control panel**

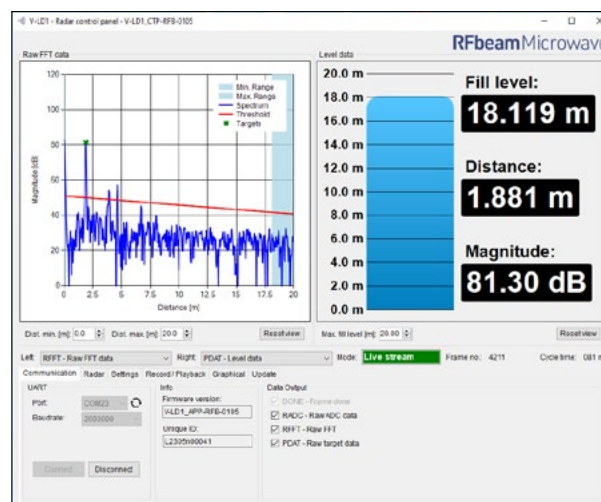

Table of contents

1	Antenna Diagram Characteristics	3
2	Pin Configurations and Functions	4
3	Installation	5
4	Quick Start	5
5	Software Update	5
6	Control Panel	6
	6.1 Views	7
	6.2 Miscellaneous Display Controls	9
	6.3 Tabs	10
7	Outline Dimensions	14
8	Order Information	14
9	Packing List	14
10	Revision History	15

1 Antenna Diagram Characteristics

This diagram shows module sensitivity in both azimuth and elevation directions. It incorporates the transmitter and receiver antenna characteristics.

Figure 2: Overall antenna diagram without lens

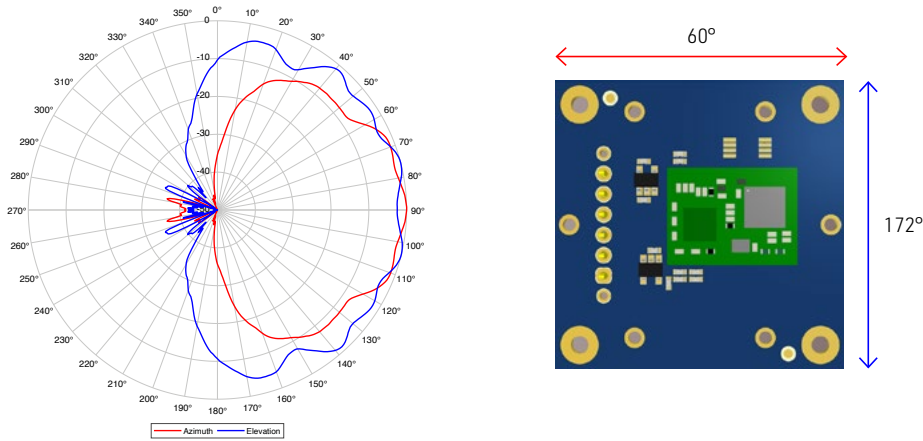
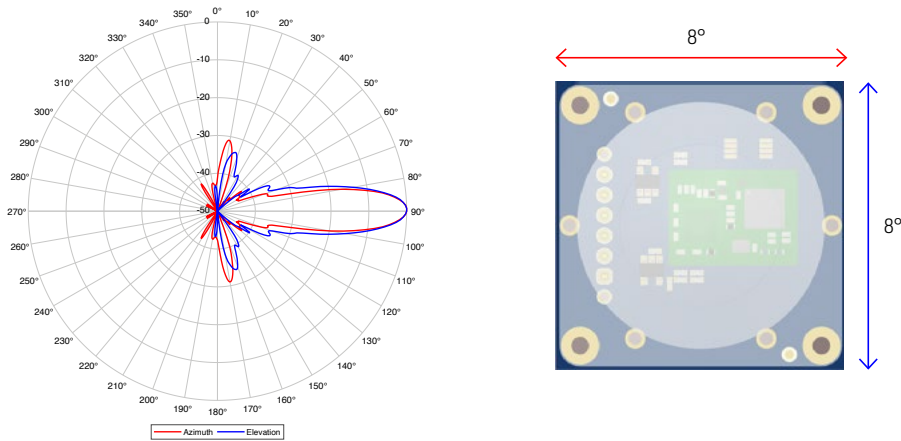

Figure 3: Overall antenna diagram with lens



The lens can focus the beam width to about 8×8 degrees and has a typical gain of 12 dBi. It is possible to integrate such a lens directly into the housing of a final product.

Do not hesitate to contact RFbeam for more information.

2 Pin Configurations and Functions

Figure 4: **Pin configuration and functions**

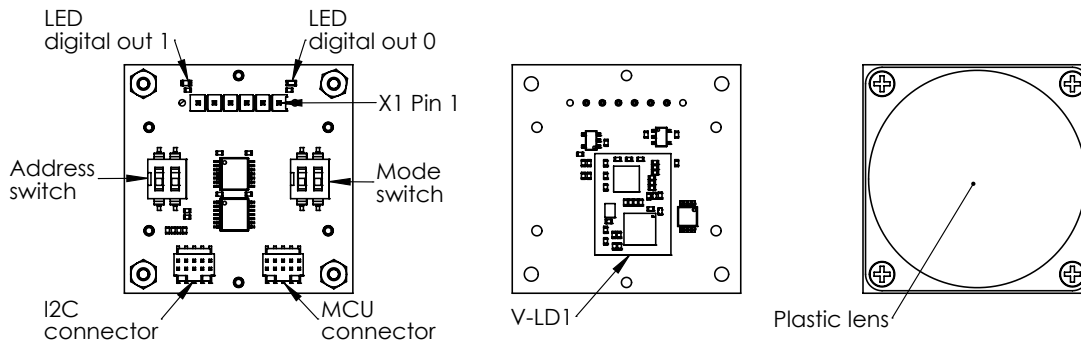

The V-LD1 evaluation kit consists of an evaluation kit PCB with a mounted V-LD1 in combination with a plastic lens which is mounted per default. The kit contains an FTDI cable which can be connected directly on connector X1 to power the sensor and create a virtual COM port connection to the PC.

Table 1: **V-LD1-EVAL connector description**

Connector	Pin. No.	Name	Description
FTDI cable	1	GND	Device ground
X1	2	CTS#	Clear to send control input
	3	VCC	Power supply pin (5V)
	4	TXD	Transmit data output
	5	RXD	Receive data input
	6	RTS#	Request to send control output

Furthermore the evaluation kit includes the following components which are reserved for future use or customization:

- Two digital output LED's
- An address switch
- A mode switch
- An I2C connector
- A programming connector

3 Installation

1. Connect the delivered USB Stick to your PC.
2. Open the installer folder on the stick.
3. Install the V-LD1 Control Panel by double clicking the set-up.exe file. If no .net framework is installed, the installer will install it automatically.

 To use the integrated video function, install and test your webcam before you proceed with the next chapter. Please download and install necessary drivers for the webcam from the manufacturer website.

4 Quick Start

1. Connect the USB cable to the X1 connector of the evaluation kit.
2. Connect the other end of the USB cable to your PC and wait until the serial COM port driver is installed.
3. Start the V-LD1 Control Panel software.
4. Select the correct COM port and click the connect button.
5. In a system with multiple webcams, a dialog will pop up. Select the webcam you want to use.
6. The Mode indicator switches to Live stream and the software is ready to use.

5 Software Update

1. Connect the USB cable to the X1 connector of the evaluation kit and to your PC.
2. Start the V-LD1 control panel and connect to the sensor. The mode display shows «Live stream» to indicate that the sensor has started the application.
3. Switch to the Update tab and jump to the bootloader by pressing the «Start Bootloader» button

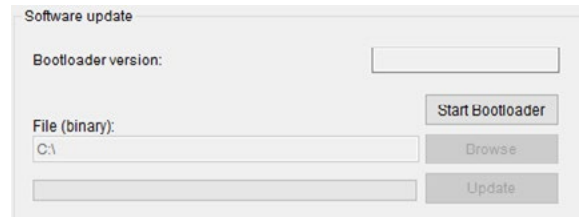

4. Reconnect the sensor by pressing the «Connect» button. Now the mode display shows «Bootloader» to indicate that the control panel is connected to the bootloader.

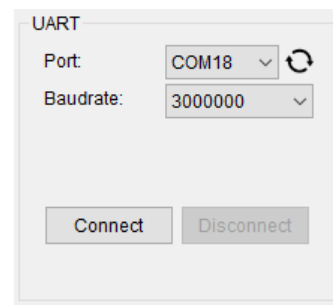

5. Use the «Browse» button to select the firmware update file provided by RFbeam Microwave and press the «Update» button to start the update.

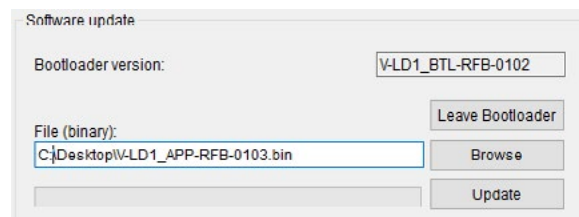

6. Wait until the process has finished. A message box indicates if the update was successful. The application starts automatically and by switching to the communication tab it is possible to directly connect to the sensor.

6 Control Panel

The control panel contains many configuration options. The structure of the panel views is designed to guide through the different steps of the radar processing, which is described in detail in the datasheet of the V-LD1.

The control panel consists of three different areas which are described in detail in the next chapters.

Figure 5: Overview control panel areas

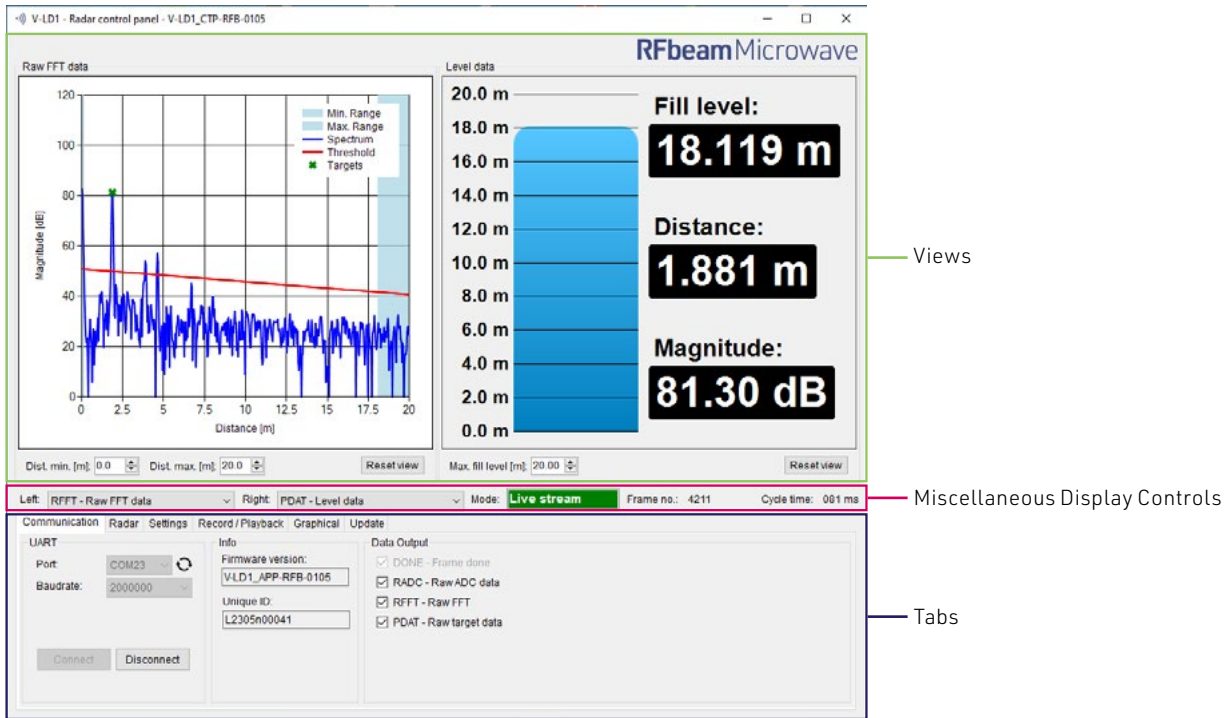

There are many views to select in the miscellaneous display controls area. All of them have a preceded shortcut based on the data output which is used in the views (RADC, RFFT, PDAT). To use the different views the according data output needs to be enabled.

For example, if «PDAT – RAW target data» is turned on in the «Data output» section, the views on the right will start to visualise the V-LD1 data.

- PDAT – Real time plot
- PDAT – Level data

Figure 6: Data output example

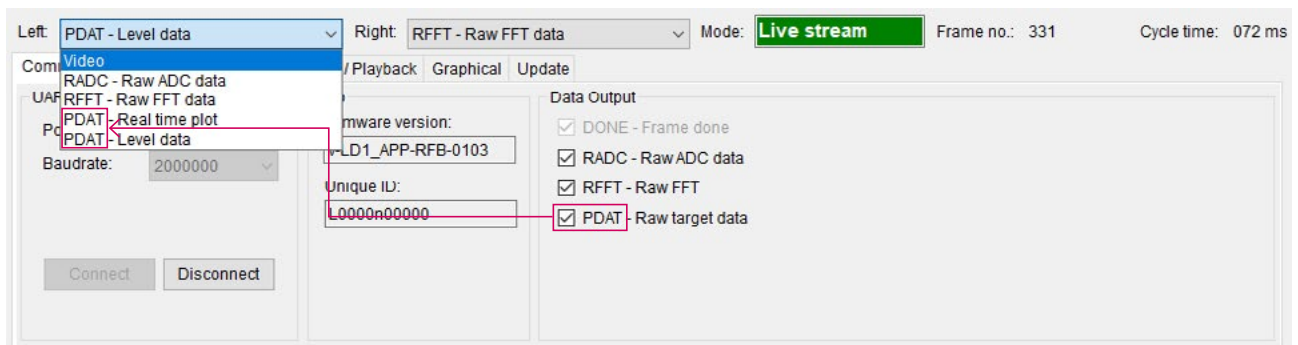

6.1 Views

The control panel features the possibility to simultaneously show two views in parallel to visualise the sensor data in different ways. How to switch between the different views is described in the chapter Miscellaneous Display Controls on page 9.

6.1.1 Video

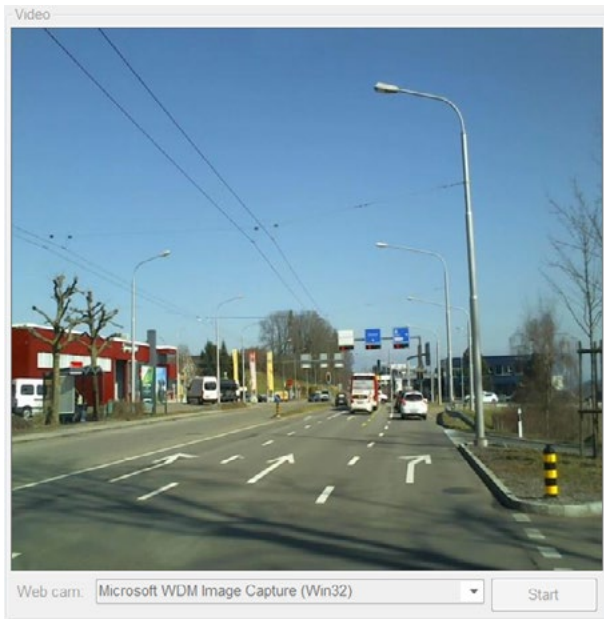

If a webcam is connected to the PC, it is possible to show the video picture in this view.

To start the video stream, the button «Start» needs to be pressed.

6.1.2 RADC - Raw ADC data

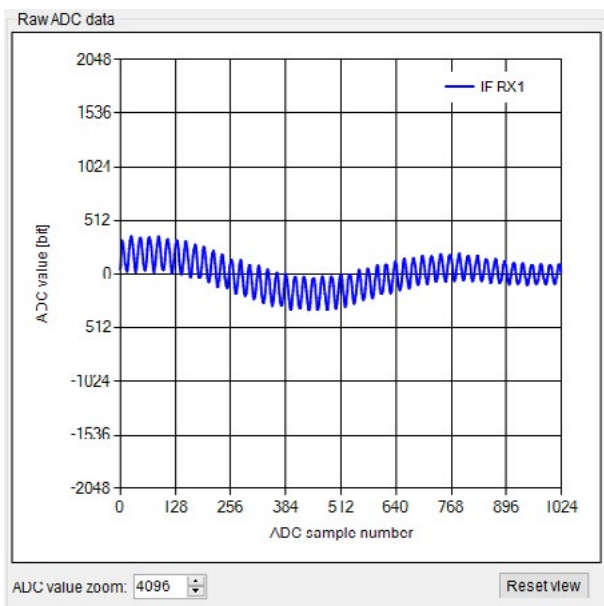

The RADC view shows all sampled ADC channels of the sensor.

A detailed description about the RADC values can be found in the V-LD1 datasheet.

ADC value zoom:
Control to zoom into the Y-axis

Reset view:
Button to reset the ADC value zoom

6.1.3 RFFT – Raw FFT data

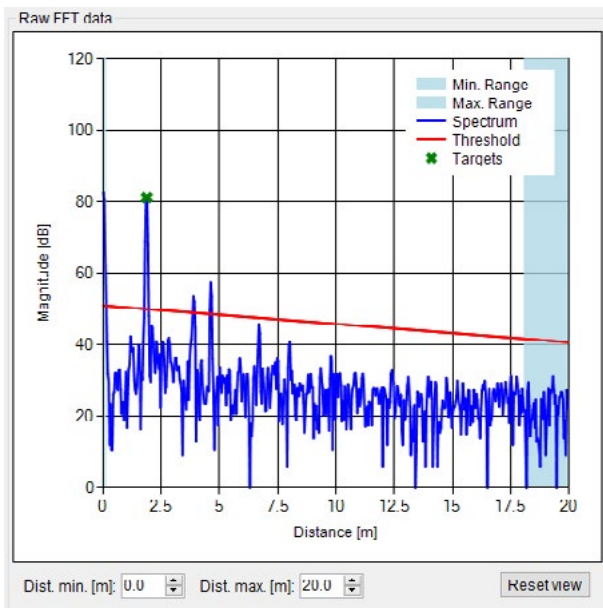

The RFFT view shows the range frequency spectrum in combination with the threshold. Furthermore the distance filter is visualised in this view.

If the PDAT data output is enabled there will be a green cross to visualise the detected target.

Dist. min. [m]:
X-axis minimum limit

Dist. max. [m]:
X-axis maximum limit

Reset view:
Button to reset the X-axis

6.1.4 PDAT – Real time plot

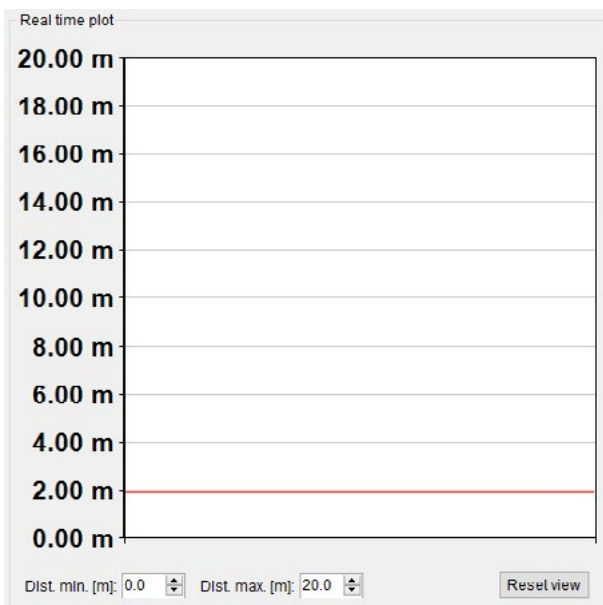

This view is very helpful to analyse the measured distance over time.

Dist. min. [m]:
Y-axis minimum limit

Dist. max. [m]:
Y-axis maximum limit

Reset view:
Button to reset the Y-axis

6.1.5 PDAT - Level data

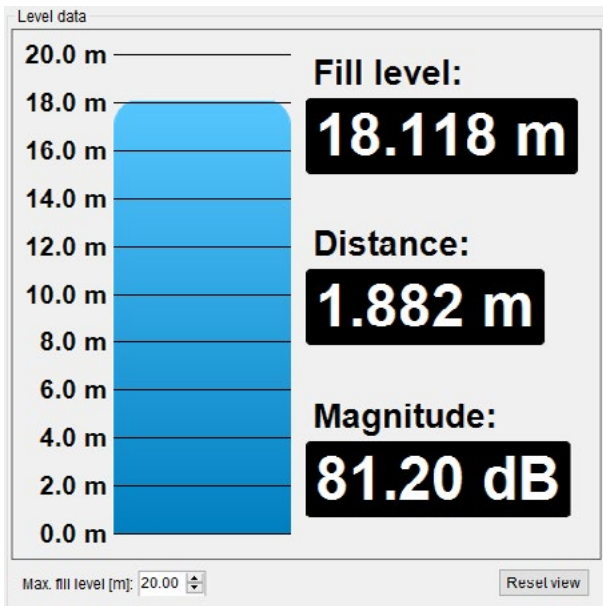

This view shows the measured distance and magnitude in real-time and provides the option to visualize it as a fill level of e.g. a tank.

Max. fill level [m]:
Height of tank for visualisation of the tank level

Reset view:
Button to reset the fill level to the default

6.2 Miscellaneous Display Controls

The middle of the control panel is used to control which views are visualised in the views area. It is easy to switch between the different views using the two drop down lists. Further the mode of the GUI, the actual frame number and the cycle time of the frames is displayed.

Figure 7: **Miscellaneous display controls**

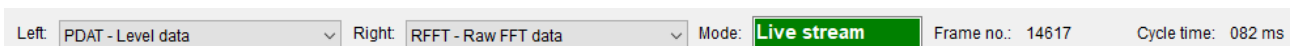



 It is not possible to display the same view left and right at the same time.

Table 2: **Different possible modes**

Mode	Description
Disconnected	No connection to the V-LD1
Live Stream	The control panel is connected to the V-LD1 and receives data
Record	Data will be recorded to the PC
Playback	Recorded data will be played and visualised
Bootloader	V-LD1 is in bootloader mode and ready for a firmware update

6.3 Tabs

This chapter describes the different control tabs of the software. It is possible to control all the parameters of the V-LD1 and all the functions of the control panel over these tabs.

 A more detailed parameter description of the sensor can be found in the datasheet of the V-LD1.

6.3.1 Communication

Figure 8: **Communication tab**

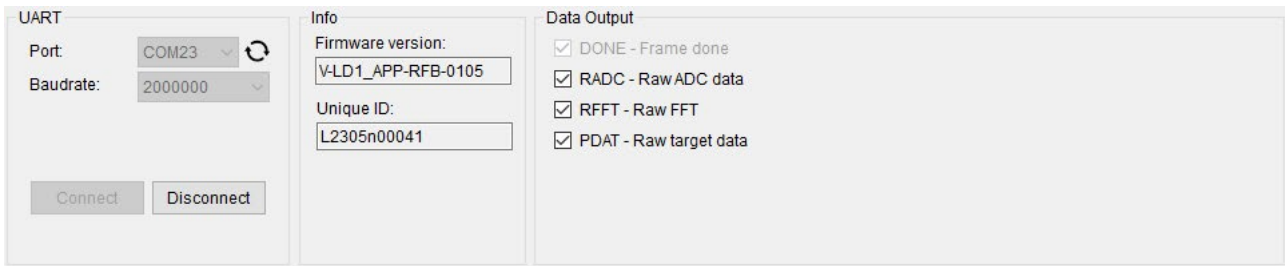

6.3.1.1 UART

To connect to the sensor, select the correct COM port of the evaluation kit in the port drop down list. The list can be updated over the refresh function (semi-circle arrows on the right of the drop down list) if the COM port is not shown correctly. Select the maximal baud rate and press the Connect button to start the communication with the V-LD1.

 If the highest baud rate does not work select a lower baud rate and try to reconnect. A lower baud rate can increase the cycle time when data intensive outputs like RADC or RFFT are enabled.

6.3.1.2 Info and Unique ID

These indicators show the firmware version and the serial number of the V-LD1 after a successful connection.

6.3.1.3 Data Output

Select which output is sent from the radar to the control panel. The according views can only show data if the corresponding data outputs are enabled.

 The cycle time can increase due to more enabled data outputs or the power of the PC. Data intensive outputs like RADC and RFFT can slow down the communication.

6.3.2 Radar

Figure 9: **Radar tab**

Radar	Detection filter
Distance range: 20m	Target filter: Nearest first
TX power: 31	Precision: High
Chirp integration count: 1	Threshold offset [dB]: 40
Short range filter: Off	Min. distance [bin]: 5 0.176 [m]
	Max. distance [bin]: 460 18.074 [m]
	Distance average: 5

This tab controls the main settings of the processing chain in the radar sensor. By changing these parameters, it is very easy to adapt the sensor to the needs of an application and check the influences in real time. A detailed description of all parameters can be found in the chapters Radar Settings and Detection settings of the V-LD1 datasheet.

6.3.3 Settings

Figure 10: **Settings tab**

Load settings	Factory settings
Load settings (V-LD1 will be updated): <input type="text" value="C:\V_LD1_Settings.bin"/> <input type="button" value="Browse"/>	Restore factory settings: <input type="button" value="Restore"/>
Save settings: <input type="text" value="C:\V_LD1_Settings.bin"/> <input type="button" value="Browse"/>	

The settings tab features the possibility to easily save and reload the complete settings of a sensor. This makes it easy to duplicate a useful dataset to multiple sensors. Furthermore it is possible to restore the default factory settings.

6.3.4 Record/Playback

Figure 11: **Record/Playback tab**

This tab can be used to record and playback the sensor data to the hard disk. It is also possible to store the video data in parallel which can be helpful to interpret the measured data in the playback mode.

6.3.4.1 Record data

To record data, you first need to specify a path where to store the data on the PC. By selecting the Store video checkbox, it is possible to also store a picture per frame from the webcam. The recording of the data can then easily be controlled over the Start and Stop button.

The software creates for every recording a new subfolder with a timestamp of the recording in the selected folder and stores a raw binary file with all received sensor data packets and the video pictures when selected. Refer to the datasheet for detailed information about the packet structure, commands and messages in the stored binary file.

 The record feature records the complete data output of the sensor specified in the communication tab under Data output. The performance of the recording may vary based on the following circumstances:

- Performance of the used PC
- Use of the video capture feature
- Enabled data output
- Used baud rate

6.3.4.2 Playback data

To playback the recorded data the control panel must be disconnected. By selecting a folder of a recorded sequence, it is possible to start, stop and pause a recording by a controlled cycle time. Even the start of the frame number in the recorded data can be chosen.

The playback feature is a very powerful tool to do an in depth analysis of the recorded data. This gives the possibility to compare the recorded data easily in all available views when the according data output was enabled for the recording.

6.3.5 Graphical

Figure 12: **Graphical tab**

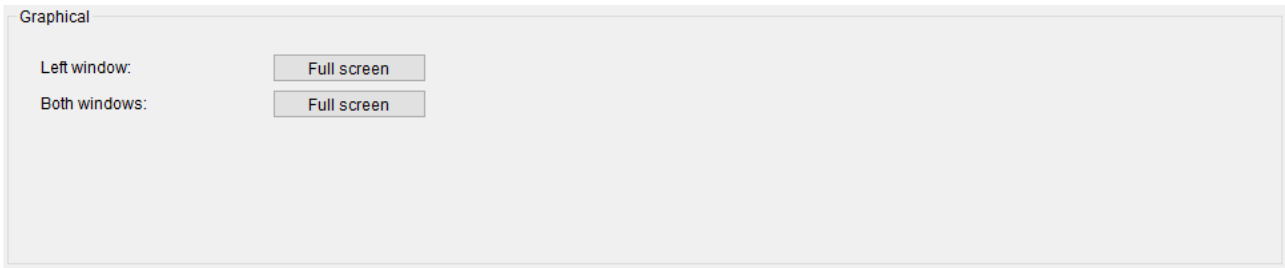

This tab offers the possibility to open a second window with a full screen view. Only the left view or a view with both views can be opened via the two «Full screen» buttons.

6.3.6 Update

Figure 13: **Update tab**

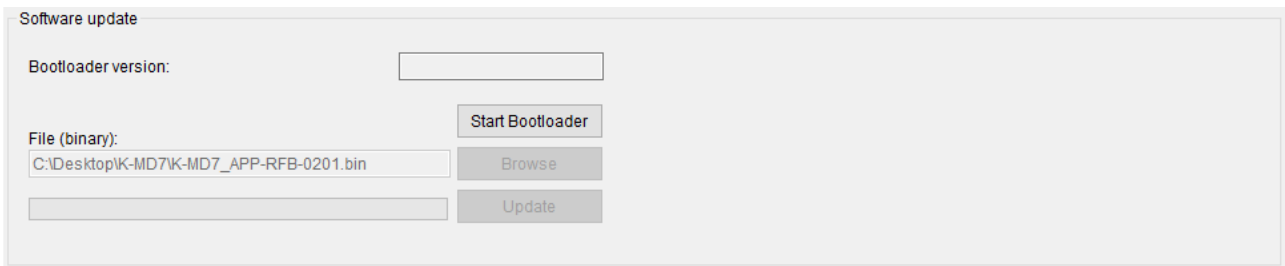

This tab allows the update of the V-LD1 firmware over the serial interface. The sensor starts to the application per default. The «Start Bootloader» button gives the option to start the bootloader out of the application.

 A step by step instruction how to update the firmware can be found in the chapter Software Update on [page 5](#).

 Use only firmware update files provided by RFbeam Microwave.

7 Outline Dimensions

Figure 14: **Outline dimensions in millimetre**

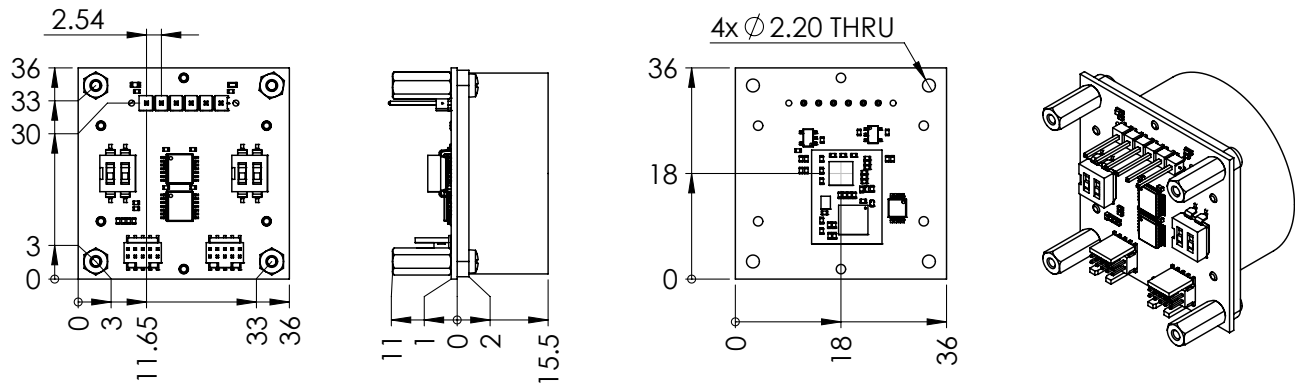

8 Order Information

The ordering number consists of different parts with the structure below

Figure 15: **Ordering number structure**

Product	-	Customer	-	HW variant	Supply
= V-LD1-EVAL		= RFB for standard products		= 00 for standard variant	= H for 3.3V...5V version

Table 3: **Available ordering numbers**

Ordering number	Description
V-LD1-EVAL-RFB-00H	Standard V-LD1 evaluation kit with powerful PC software

9 Packing list

1. Assembled evaluation kit PCB board
 - a. Includes V-LD1 sensor
 - b. Detachable plastic lens mounted
2. USB cable
3. USB stick containing
 - a. Control panel software
 - b. Documentation
 - c. Example readout script

10 Revision History

- 05 / 2023 - Revision A: Initial Version
- 11 / 2024 - Revision B: Changed orientation
of module for antenna diagrams

Fbeam does not assume any responsibility for use of any circuitry described, no circuit patent licenses are implied and RFbeam reserves the right at any time without notice to change said circuitry and specifications